



**INSTALLATION AND
OPERATING INSTRUCTIONS FOR
WALL MOUNT UNIT
WM-2134**

**INSTALLER: LEAVE THIS MANUAL WITH THE APPLIANCE. CONSUMER:
RETAIN THIS MANUAL FOR FUTURE REFERENCE.**



QUICK REFERENCE GUIDE

- I. Prior to installation, please ensure:
 1. The rated voltage of your firebox fits the output voltage of your outlet;
 2. The light bulbs in your firebox are in good condition. For checking this, please follow the instructions for replacing the light bulbs on section MAINTENANCE.
- II. The heater on your fireplace may emit a slight, harmless odor when first used. This odor is a normal condition caused by the initial heating of internal heater parts and will not occur again.
- III. If your heater does not emit heat, please ensure the Heater Switch is on. For further information, please consult section Operation of the Practical User's Guide.

Marks

NOTE

Procedures and techniques, that are considered important enough to emphasize.

CAUTION

Procedures, which if not carefully followed, will result in damage to the equipment.

WARNING

Procedures, which if not carefully followed, will expose the user to the risk of serious injury, illness or death.

IMPORTANT INSTRUCTIONS

WARNING

You should read and always follow the important instructions below to reduce the risk of fire, electric shock, and injury to persons.

1. Read all instructions before using this fireplace.
2. This fireplace is hot when in use. To avoid burns, do not let bare skin touch hot surfaces, such as surfaces near the heater outlet or light bulbs. The grill directly in front of the heater outlet becomes hot during heater operation. Keep combustible materials, such as clothes, pillows, furniture, bedding, papers and curtains at least 3 feet from the front of the unit. Do not cover or block heater outlet or any ventilation or exhaust opening at any time. Do not use on soft surfaces where openings may become blocked.
3. Extreme caution is necessary when any heater is used by or near children or invalids and whenever the heater is left operating and unattended.
4. Do not install the fireplace directly on carpet or a similar surface, which may restrict air circulation beneath the unit.
5. Always unplug fireplace when not in use.
6. To disconnect fireplace, turn controls to off, then remove plug from outlet.
7. Do not use outdoors.
8. This fireplace is not intended for use in wet locations, such as bathrooms, laundry areas and similar indoor locations. Never locate fireplace where it may fall into water container.
9. Do not operate the fireplace with a damaged cord or plug, or if the fireplace has malfunctioned, or if the fireplace has been dropped or damaged in any manner. Return fireplace to authorized service for examination, adjustment or repair.
10. Do not run cord under carpeting. Do not cover cord with throw rugs, runners, or the like. Arrange cord away from traffic area and where it will not be tripped over.
11. Do not insert or allow foreign objects to enter any ventilation or exhaust opening as this may cause an electric shock or fire, or damage the firebox.
12. To prevent a possible fire, do not block air intakes or exhaust in any manner. Do not use on soft surfaces, like a bed, where openings may become blocked.
13. All electrical heaters have hot and arcing or sparking parts inside. Do not use it in areas where gasoline, paint, or flammable liquids are used or stored or where the unit will be exposed to flammable vapors.
14. Do not modify this fireplace. Use it only as described in this manual. Any other use not recommended by the manufacturer may cause fire, electric shock or injury to persons.
15. Avoid the use of an extension cord because the extension cord may overheat and cause a risk of fire. However, if you have to use an extension cord, the cord shall be 16AWG minimum size and rated not less than 125V/15A or 2500 watts.
16. Do not burn wood or other materials in this fireplace.
17. If the supply cord is damaged, it must be replaced by a special cord or assembly available from the manufacturer or its service agent.
18. Do not strike fireplace glass.
19. Always use a certified electrician should new circuits or outlets be required.
20. Always use properly grounded, fused and polarized outlets.
21. Always use ground fault protection where required by electrical code.
22. The heater must not be located immediately below a socket-out.
23. Always disconnect power before performing any cleaning, maintenance or relocation of the fireplace.
24. When transporting or storing the fireplace and cord, keep in a dry place, free from excessive vibration and store so as to avoid damage.
25. WARNING: In order to avoid overheating, do not cover the heater.
26. This appliance is not intended for use by persons (including children) with reduced physical, sensory or mental capabilities, or lack of experience and knowledge, unless they have been given supervision or instruction concerning use of the appliance by a person responsible for their safety.
27. Children should be supervised to ensure that they do not play with the appliance.
28. Indoor and household use
29. CAUTION: In order to avoid a hazard due to inadvertent resetting of the thermal cutout, this appliance must not be supplied through an external switching device, such as a timer, or connected to a circuit that is regularly switched on and off by the utility.

INSTALLATION

This section provides step-by-step instructions for installation of your fireplace.

WARNING

The outlet must be **15A/125V**.

CAUTION

1. This fireplace is designed to be able to hang on solid walls or insert into a wall hole after proper construction. Select a suitable location, which is not susceptible to moisture, safe, dust free, away from high traffic and away from things may catch fire or block openings such as drapes, furniture, etc.
2. The fireplace must be installed at a suitable position where at least 50cm above the floor and no higher than 180cm.

NOTE

It is a good idea to place your fireplace near an existing outlet, for ease of electrical hook up.

CAUTION

Store your fireplace insert in a dry, safe and dustless place when placing the mantel or building the wall construction.

WARNING

Do not attempt to wire you own new outlets or circuits. To reduce the risk of fire, electric shock or injury to persons, always use a licensed electrician.

1. If there's no **15A/125V** outlet near the desired location, install a new one near or behind mantel.
2. Make sure the fireplace insert is switched off (refer to operation instruction section).
3. Plug the fireplace into a **15A/125V** outlet. Wiring the cord along the corner of wall.
4. There is 2 keyholes on the back side of the fireplace casing, place the mantel in the desired location and drill 2 holes according to the position of the 2 keyholes. Then insert 2 expansion bolts. Use strong screws to fix it on the wall, each of the screw needs to come out of the wall for 8mm, ensure that the screw are well fixed then lift the fireplace and make the keyholes a little higher than the screw's position, then make the screws slide slowly into the keyholes until it take the whole weight of the fireplace.

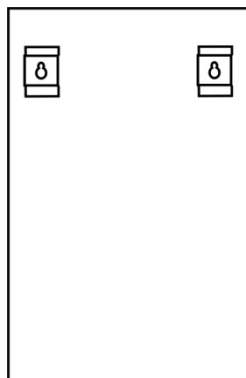

OPERATION

This section will explain the function of each convenient control.

NOTE

The heater may emit a slight, harmless odor when first used. This odor is a normal condition caused by initial heating of internal heater parts and will not occur again.

• Control Panel Operation

A. Buttons and indicators

There are four buttons on the remote controller, and four on the control panel of the fireplace, each pair of buttons with the same label perform the same function, the back of it is manual switch near the power cord:

<I/O> button is main power switch;

<ON/OFF> button is power switcher of the electric fireplace;

<DIMMER> button is used to adjust the brightness of simulated flame and logs;

<LOW> button turns the heater on and switches it to low-power status. If the heater already is, turn it off;

<HIGH> button turns the heater on and switches it to high-power status. If the heater already is, turn it off;

There are four indicators on the control panel:

 is the power indicator, it light up when the fireplace is working, and turned out when the fireplace is turned off;

 indicates the status of the simulated flame and logs. It's brighten up when the flame simulate component is working, and will be flashing when you adjusting the brightness of the flame;

 indicates the heater is working in low-power status;



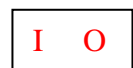
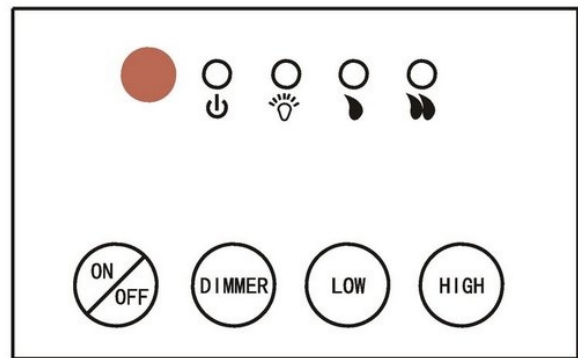





 indicates the heater is working in high-power status.



The red window on the control panel of fireplace is the eye of receiver, do not cover.

B. Operation

On the first usage of remote controller, install the batteries first: open the battery box by sliding its cover along the arrow, install two AAA batteries according to the marks in the box, and slide the cover to its original position. If no batteries installed or the batteries are bad, the remote controller will be unusable. To use the remote controller effectively, point it to the electric fireplace and keep a distance of 1-5 meters. The four buttons are marked the same as buttons on the remote controller, each pair of them perform the same function, choose as you favour.

1. Power control. Press the <ON/OFF> button, the electric fireplace will be powered on, and the  lamp will brighten up. The heater will not be turned on automatically when you power on the fireplace, please refer to paragraph 3. Note, all operations are valid only when the power is on, except to "turn the power on" operation. Press the <ON/OFF> button again, the fireplace will be powered off.
2. Adjust the brightness of simulated flame and logs. When the fireplace is powered on, flame is turned on automatically, and it is as bright as when the fireplace is powered off. Press <DIMMER> button to adjust the brightness, the  lamp will be flashing, and the brightness of the flame and logs will start and keep changing. When the brightness goes to the point you want, press <DIMMER> button again, and the brightness will keep still and the  lamp will keep brighten up.
3. Heater control. Lamp  and  indicates the status of heater. It's working in low-power status when  is brighten up, in high-power status when  is lit up, turned off when both of  and  is dark. When the heater is not in low-power



status (🔦 is dark), press <LOW> button will switch it to low-power status; when it's in low-power status (🔦 is brighten up), press <LOW> button will turn it off. Similarly, a <HIGH> button press will switch the heater to high-power status when 🔦 is dark, and turn it off when 🔦 is lit up. Note, before the heater emits heat or after it stop producing heat, the hot air outlet may output air for 10 seconds. This is designed for protected circuit, and it's not spoiled.

4. Power off the electric fireplace when you leave it for a long time.
5. The two alkaline batteries must be removed from the appliance before it is scrapped.
6. The alkaline battery is to be disposed of safely.

MAINTENANCE

WARNING

Disconnect power before attempting any maintenance or cleaning to reduce the risk of fire, electric shock to persons or damage.

Light Bulb Replacement

Light bulbs need to be replaced when you notice a dark section of the flame or when the clarity and detail of the log exterior disappears. There are two bulbs under the log set.

WARNING

Allow at least 5 minutes for light bulbs to cool off before touching bulbs to avoid burning of skin.

I. Bulb Requirements

Quantity of 2 clear chandelier or candelabra bulbs with an E-12 (small) socket base, rating voltage 125 volts, rating power 40 watts.

CAUTION

Do not exceed 40 watts per bulb

II. Operation

1. Open the light bulb area:
The light bulb area is at the front of electric fireplace, see "E" there are 2 screws on it, loosen the screw with screwdriver. (Under figure)
2. Examine the bulbs to determine which bulbs require replacement.
3. Remove old bulb and replace a new one. Hold the socket while unscrewing or screwing bulbs. (Right figure)
4. Replace the cover of light bulbs.
5. Done.

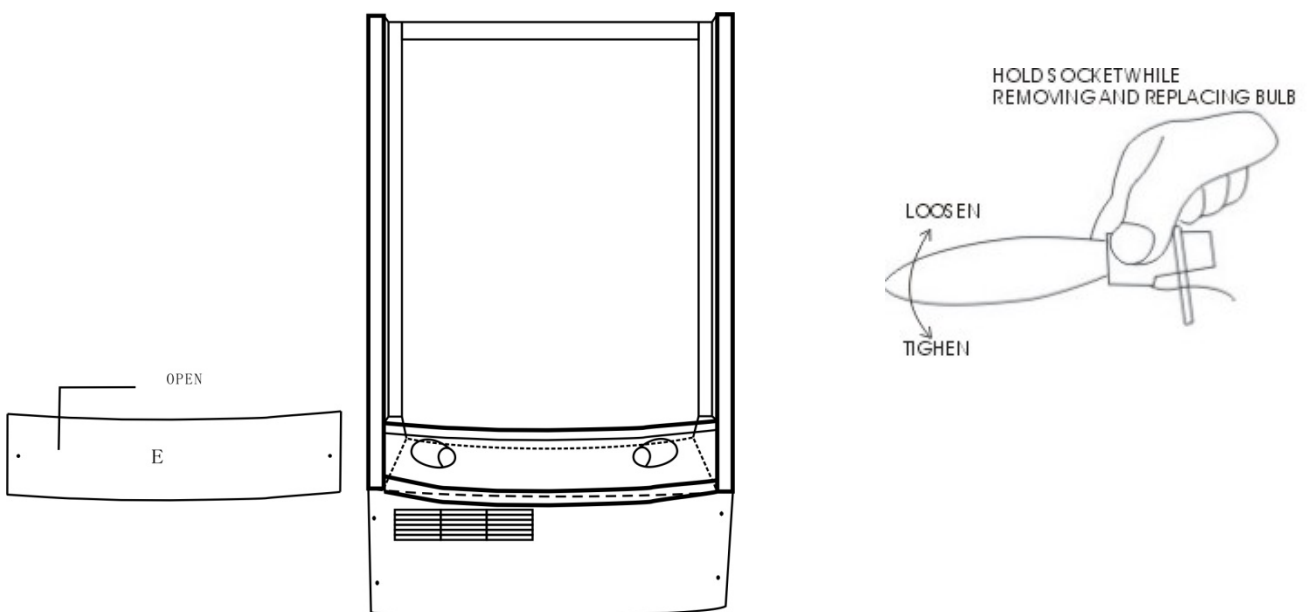

Correct Disposal of this product



This marking indicates that this product should not be disposed with other household waste. To prevent possible harm to the environment or human health from uncontrolled waste disposal, recycle it responsibly to promote the sustainable reuse of material resources. To return your used device, please use the return and collection systems or contact the retailer where the product was purchased. They can take this product for environmental safe recycling.

WARRANTY

Amantii Imports Corp. ("Amantii") warrants that your newly purchased Amantii electric fireplace is free from manufacturing and material defects for a period of one (1) year from the date of the first purchase, subject to the conditions and limitations contained below.

Warranty Application & Exclusions

This limited warranty applies to your newly purchased Amantii electric fireplace; the limited warranty's application is limited to purchases made in any province of Canada or in any of the 52 States of the United States of America, including the District of Columbia. Only the original purchaser of the product is eligible for coverage under this limited warranty; the warranty is not transferable.

Products excluded from this limited warranty

Light bulbs are not covered by this limited warranty and are the sole responsibility of the owner/purchaser.

Warranty Coverage and Term

Products covered by this limited warranty have been tested and inspected prior to shipment and, subject to the provisions of this warranty, Amantii warrants such products to be free from defects in material and workmanship for a period of one (1) year from the date of the first purchase of such products.

The limited one (1) year warranty period for products also applies to any implied warranties that may exist under applicable law. Some jurisdictions do not allow limitations on how long an implied warranty lasts, so the above limitation may not apply to the purchaser.

All other warranties—expressed or implied—with respect to the product, its components and accessories or any obligation/liabilities on the part of Amantii are hereby expressly excluded.

Limitations to Coverage Under Limited Warranty

This limited warranty does not apply to products that have been repaired, except by Amantii or its authorized service representatives, or otherwise altered. This limited warranty further does not apply to defects resulting from misuse, abuse, accident, neglect, incorrect installation, improper maintenance or handling, or operation with an incorrect power source.

Products made by other manufacturers, sold with the product or thereafter, are not covered by this limited warranty. The use of unauthorized components will render this warranty null and void.

Service Under Limited Warranty

Defects must be brought to the attention of Amantii Technical Service by contacting Amantii at (1-888-406-8764), or at 1503 – 7088 18th Avenue, Burnaby, British Columbia, Canada, V3N 0A2. Please have your proof of purchase, catalogue/model and serial numbers available when calling; any and all service under the limited warranty requires a proof of purchase of the product.

Defects

Should a product or part covered by this limited warranty be proven to be defective, in material or workmanship, and during the one (1) year limited warranty period, Amantii will replace such defective product or part without charge. If Amantii is unable to replace such product, or if replacement is not commercially practicable or cannot be timely done, in its sole discretion Amantii may, in lieu of replacement, choose to refund the purchase price for such product or part.

Limitations

In no event will Amantii, including without limitation any of its directors, officers, shareholders, employees, consultants, agents, heirs, executors, administrators and assigns, be liable to the purchaser or any third party, whether in contract, in tort, or on any other basis for any indirect, special, punitive, exemplary, consequential, or incidental loss, cost or damage arising out of or in connection with the sale, maintenance, use or inability to use the product, even if Amantii, including without limitation any of its directors, officers, shareholders, employees, consultants, agents, heirs, executors, administrators and assigns, have been advised of the possibility of such losses, costs or damages, or if such losses, costs or damages are foreseeable. In no event will Amantii, including without limitation any of its directors, officers, shareholders, employees, consultants, agents, heirs, executors, administrators and assigns, be liable for any direct losses, costs or damages that exceed the purchase price of the product.

Some jurisdictions do not allow the exclusion or limitation of incidental or consequential damages, so the above limitation or exclusion may not apply to the purchaser.

Application of Provincial and State Law

This limited warranty gives you specific legal rights, and you may also have other rights which vary from jurisdiction to jurisdiction. The provisions of the United Nations Convention on Contracts for the Sale of Goods shall not apply to this limited warranty or the sale of products covered by this limited warranty.

General

Amantii reserves the right to make changes at any time without notice, in design, material, specifications, prices and the right to discontinue styles and products.



www.amantii.com

Date of Purchase:

Dealer Information: