

01. INSTALLATION / OWNERS MANUAL



BI-DEEP-LUMINA



SAFETY INFORMATION



WARNING

If the information in these instructions are not followed exactly, a fire or explosion may result causing property damage, personal injury or loss of life.

Do not store or use gasoline or other flammable vapors and liquids in the vicinity of this or any other.

MODEL SKU:

- DE-190040-1
BI-40-DEEP
LUMINA
- DE-190050-1
BI-50-DEEP
LUMINA
- DE-190060-1
BI-60-DEEP
LUMINA
- DE-190072-1
BI-72-DEEP
LUMINA
- DE-190088-1
BI-88-DEEP
LUMINA



CONSUMER: RETAIN THIS MANUAL FOR FUTURE REFERENCE.

INSTALLER: LEAVE THIS MANUAL WITH THE APPLIANCE.



WARNING: This product can expose you to chemicals including lead in the wiring, which is [are] known to the State of California to cause birth defects or other reproductive harm. For more information visit: www.p65warnings.ca.gov

TABLE OF CONTENTS

Please read and carefully follow all of the instruction found in this manual. The instructions included here will assure that you have many years of dependable and enjoyable service from your Amantii product.

IMPORTANT INSTRUCTIONS	3
FCC CAUTIONS	4
UNPACKING AND TESTING THE APPLIANCE	5
GROUNDING APPLIANCE	5
LOCATING THE FIREPLACE.....	5
BI-40-DEEP-LUMINA (DE-190040-1)	6
BI-50-DEEP-LUMINA (DE-190050-1)	7
BI-60-DEEP-LUMINA (DE-190060-1)	8
BI-72-DEEP-LUMINA (DE-190072-1)	9
BI-88-DEEP-LUMINA (DE-190088-1)	10
MANTEL CLEARANCE.....	11
FOR BATHROOM USE	11
SAFETY DRILL SCREW AREA	12
OUTDOOR INSTALLATION.....	12
INSTALLATION.....	13
HARDWIRE INSTALLATION	19
PANORAMA COVER INSTALLATION.....	20
MEDIA OPTIONS.....	21
DECORATIVE MEDIA INSTALLATION.....	21
OPERATION.....	22
MANUAL OPERATION	22
REMOTE CONTROL OPERATION.....	23
WIFI OPERATION.....	26
REPLACEMENT PARTS	29
EXPLODED VIEW	30
TROUBLE SHOOTING.....	31
SERVICE HISTORY.....	32
WARRANTY	33

QR Code



IMPORTANT INSTRUCTIONS

PLEASE RETAIN THIS USER GUIDE FOR FUTURE REFERENCE

When using electrical appliances, basic precautions should always be followed to reduce the risk of fire, electric shock, and injury to persons, including the following:

- 1) Read all instructions before using this fireplace
- 2) The fireplace is hot when in use. To avoid burns, do not let bare skin touch hot surfaces. Keep combustible material such as furniture, cushions, bedding, paper, clothes, curtains at least 3 feet from the front of the unit
- 3) Extreme caution is necessary when any heater is used near children and whenever the unit is left operating and unattended.
- 4) Do not operate a fireplace with a damaged cord or plug, or if the heater has malfunctioned, the fireplace has drooped or damaged in any manner
- 5) Not all fireplaces are suitable for use in bathrooms or laundry facilities. Please consult with individual product literature to confirm suitability
- 6) Do not run the cord under carpeting. Do not cover cord with throw rugs, runners or the like. Arrange the cord away from traffic area and where it will not be tripped over
- 7) Do not modify this fireplace. Use it as described in the manual. Any other use not recommended by the manufacture may cause fire, shock or injury to persons
- 8) Do not use this heater with programmer, timer, separate remote-control system or any other device that switches the heater on automatically, since a fire risk exists if the heater is covered or positioned incorrectly
- 9) Disconnect all power supply before cleaning, maintenance or relocation of the fireplace
- 10) Keep the heater clean. Do not allow any objects to enter any ventilation or exhaust opening as this may cause electric shock, fire or damage to the heater
- 11) Do not immerse the cord, plug or any part of the appliance in water or any other liquid
- 12) In order to avoid a hazard due to inadvertent resetting of the thermal cut-out, this appliance must not be supplied through an external switching device

SAVE THESE INSTRUCTIONS

CAUTION: Procedures and techniques, which, if not carefully followed, will result in damage to the equipment.

WARNING: Procedures and techniques, which, if not carefully followed, will expose the user to the risk of fire, serious injury, illness or death.

Consult with professional electrician and adhere to all code requirements for installations in bathrooms

FCC CAUTIONS

This device complies with part 15 of the FCC Rules. Operation is subject to the following two conditions: (1) This device may not cause harmful interference, and (2) this device must accept any interference received, including interference that may cause undesired operation.

Any Changes or modifications not expressly approved by the party responsible for compliance could void the user's authority to operate the equipment.

Note: This equipment has been tested and found to comply with the limits for a Class B digital device, pursuant to part 15 of the FCC Rules. These limits are designed to provide reasonable protection against harmful interference in a residential installation. This equipment generates uses and can radiate radio frequency energy and, if not installed and used in accordance with the instructions, may cause harmful interference to radio communications. However, there is no guarantee that interference will not occur in a particular installation. If this equipment does cause harmful interference to radio or television reception, which can be determined by turning the equipment off and on, the user is encouraged to try to correct the interference by one or more of the following measures:

Reorient or relocate the receiving antenna.

Increase the separation between the equipment and receiver.

Connect the equipment into an outlet on a circuit different from that to which the receiver is connected.

Consult the dealer or an experienced radio/TV technician for help.

This equipment complies with FCC radiation exposure limits set forth for an uncontrolled environment. This equipment should be installed and operated with minimum distance 20cm between the radiator & your body.

UNPACKING AND TESTING APPLIANCE

Carefully remove the appliance from the box.

Prior to installing the appliance, test to make sure the appliance operates properly by plugging the power supply cord into a conveniently located 120 Volt grounded outlet.

Test all aspects of its operation (manual switches, remote and heater) to make sure all components operate correctly.

As with most electronic devices, your new electric fireplace has been designed to operate at temperatures between 5 °C (41°F) and 35 °C (95°F). During the cold winter months, allow the fireplace to reach room temperature before turning it on.

NOTE: There may be trace of odor during the first few minutes of initial use. This is harmless, normal and will never occur again.

GROUNDING APPLIANCE

This appliance is for use on 120 Volts. The cord has a plug as shown in (A). An adapter as shown in (C) is available for connecting three-blade grounding type plugs to two-slot receptacles. The green grounding lug extending from the adapter must be connected to a permanent ground such as a properly grounded outlet box. The adapter should not be used if a three-slot grounded receptacle is available.

To disconnect appliance, turn controls to off, then remove plug from outlet.

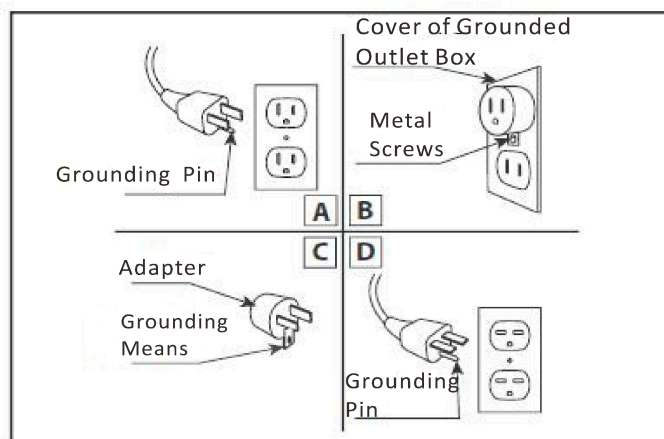

Note : Adaptor are NOT for use in Canada

LOCATING THE FIREPLACE

Plan where to locate and frame the fireplace. This will save time and money later when you install the fireplace. Before installation consider the following:

1. Where the fireplace is located must allow for wall and ceiling clearances
2. Consider a location where the fireplace screen will not be exposed to direct sunlight from windows or doors.
3. A 15 ampere, 120 Volt, 60 Hz branch circuit with proper ground must be available at the location. Preferably a dedicated branch circuit should be provided to avoid circuit breakers to trip or fuses to blow.

BI-40-DEEP-LUMINA (DE-190040-1)

Description	Built-in Appliance
Voltage	120V AC 60Hz
Watts	1500W Max
NO HEATER	28.6W
MOTOR HEATER	19W
Appliance Width	38 5/8" or 98.1 cm
Appliance Height	23 5/8" or 60 cm
Appliance Depth	12 5/8" or 32.2 cm
Gross Weight	94.6lbs or 43kg
Plug Location	Left side
Cord Length	70 7/8" or 180 cm
Rough Wall Opening Size	40" × 25" or 101.6 cm × 63.5 cm
BTU	5000

This appliance has been tested in accordance with the UL Standard 2021 for fixed and location dedicated electric room appliances in the United States and Canada. If you need assistance during installation, please contact your local dealer.

NOTE: This appliance must be electrically wired and grounded in accordance with local codes. In the absence of local codes, use the current **CSA C22.1 Canadian Electrical Code in Canada** or the **ANSI/NFPA 70 National Electrical Code in the United States**.

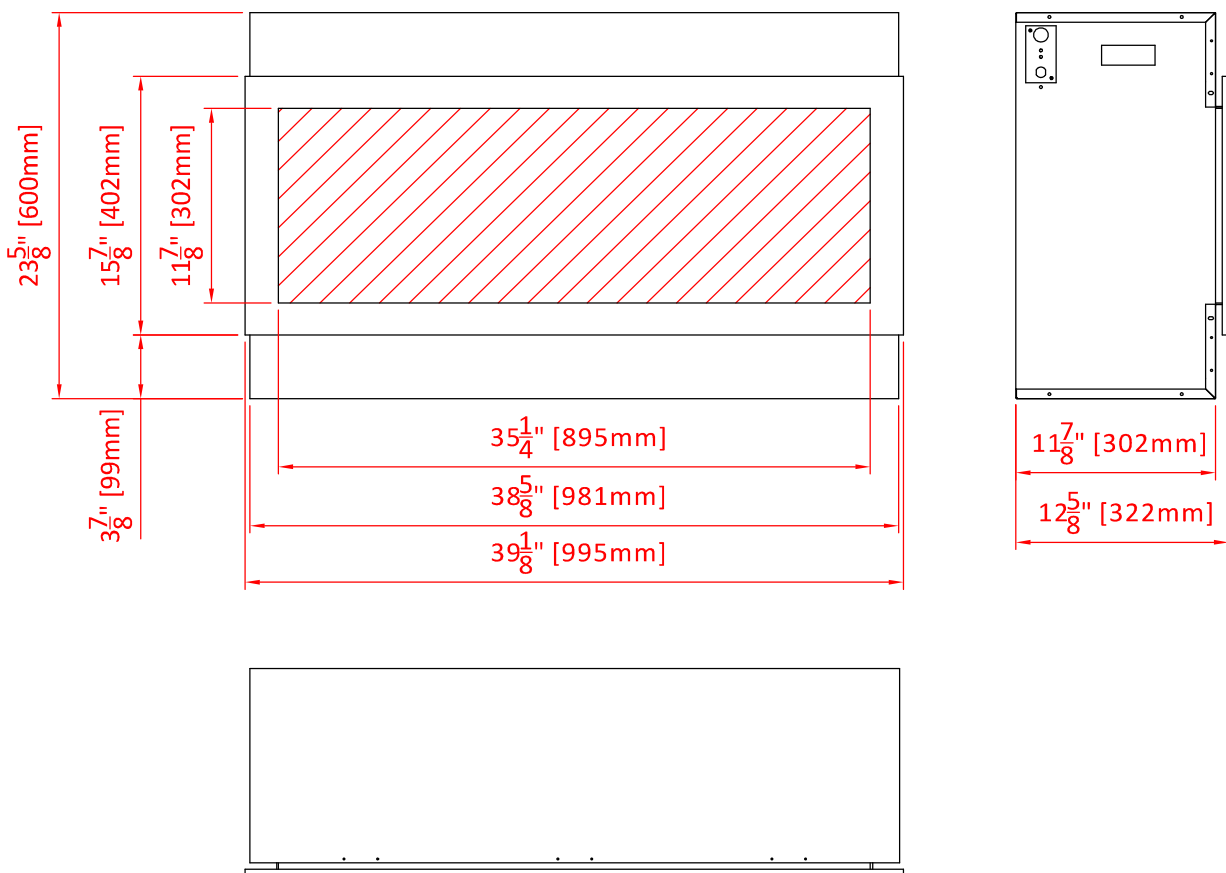

BI-50-DEEP-LUMINA (DE-190050-1)

Description	Built-in Appliance
Voltage	120V AC 60Hz
Watts	1500W Max
NO HEATER	33.6W
MOTOR HEATER	19W
Appliance Width	48 5/8" or 123.5 cm
Appliance Height	23 5/8" or 60 cm
Appliance Depth	12 5/8" or 32.2 cm
Gross Weight	110lbs or 50kg
Plug Location	Left side
Cord Length	70 7/8" or 180 cm
Rough Wall Opening Size	50" × 25" or 172 cm × 63.5 cm
BTU	5000

This appliance has been tested in accordance with the UL Standard 2021 for fixed and location dedicated electric room appliances in the United States and Canada. If you need assistance during installation, please contact your local dealer.

NOTE: This appliance must be electrically wired and grounded in accordance with local codes. In the absence of local codes, use the current **CSA C22.1 Canadian Electrical Code in Canada** or the **ANSI/NFPA 70 National Electrical Code in the United States.**

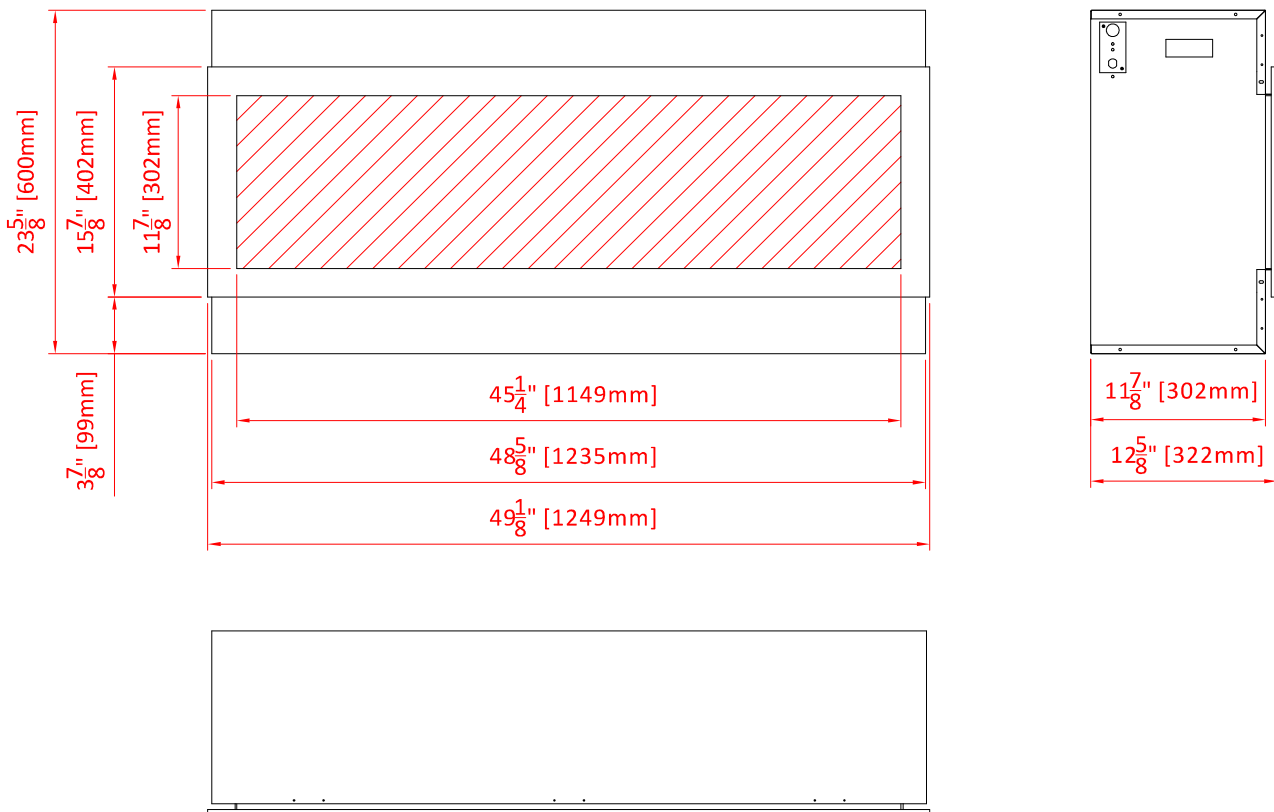

BI-60-DEEP-LUMINA (DE-190060-1)

Description	Built-in Appliance
Voltage	120V AC 60Hz
Watts	1500W Max
NO HEATER	36.6W
MOTOR HEATER	19W
Appliance Width	58 5/8" or 148.5 cm
Appliance Height	23 5/8" or 60 cm
Appliance Depth	12 5/8" or 32.2 cm
Gross Weight	127.6lbs or 58kg
Plug Location	Left side
Cord Length	70 7/8" or 180 cm
Rough Wall Opening Size	60" × 25" or 152.4 cm × 63.5 cm
BTU	5000

This appliance has been tested in accordance with the UL Standard 2021 for fixed and location dedicated electric room appliances in the United States and Canada. If you need assistance during installation, please contact your local dealer.

NOTE: This appliance must be electrically wired and grounded in accordance with local codes. In the absence of local codes, use the current **CSA C22.1 Canadian Electrical Code in Canada** or the **ANSI/NFPA 70 National Electrical Code in the United States.**

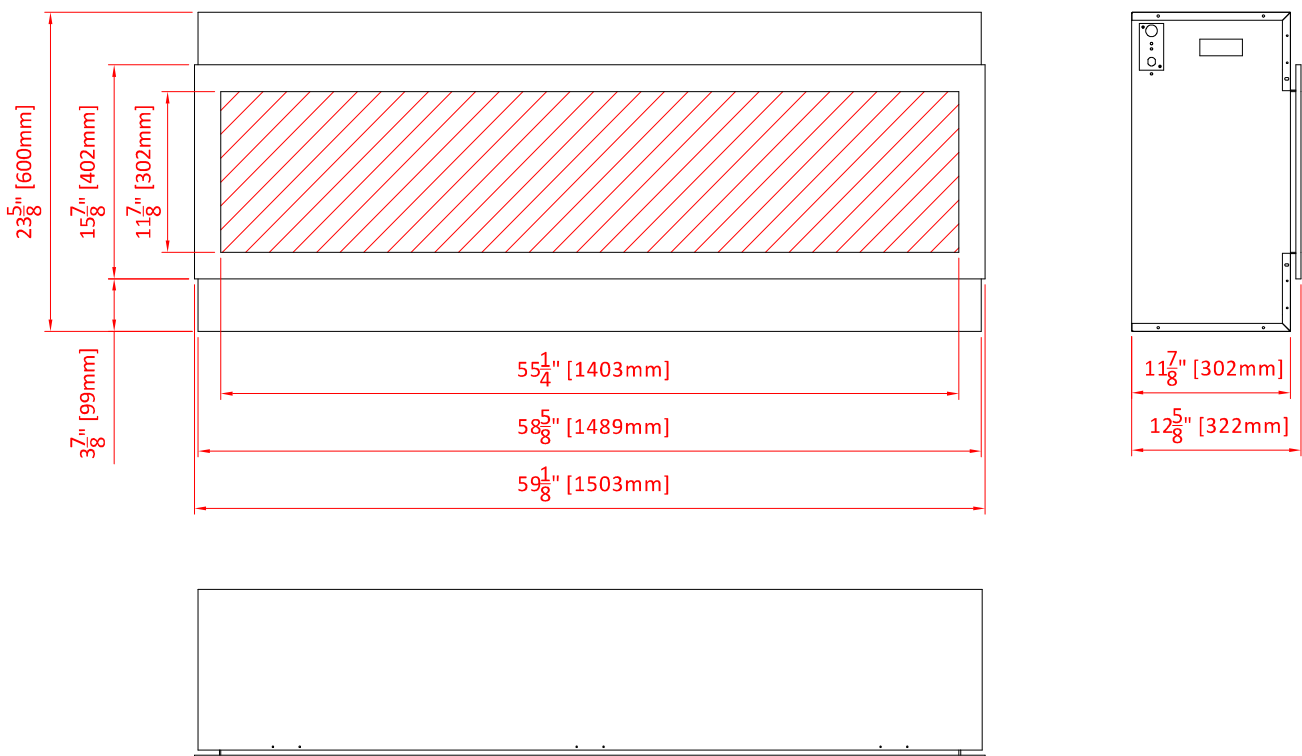

BI-72-DEEP-LUMINA (DE-190072-1)

Description	Built-in Appliance
Voltage	120V AC 60Hz
Watts	1500W Max
NO HEATER	41.4W
MOTOR HEATER	19W
Appliance Width	72 1/8" or 183.2 cm
Appliance Height	23 5/8" or 60 cm
Appliance Depth	12 5/8" or 32.2 cm
Gross Weight	156.2lbs or 71kg
Plug Location	Left side
Cord Length	70 7/8" or 180 cm
Rough Wall Opening Size	73 1/2" × 25" or 186.7 cm × 63.5 cm
BTU	5000

This appliance has been tested in accordance with the UL Standard 2021 for fixed and location dedicated electric room appliances in the United States and Canada. If you need assistance during installation, please contact your local dealer.

NOTE: This appliance must be electrically wired and grounded in accordance with local codes. In the absence of local codes, use the current **CSA C22.1 Canadian Electrical Code in Canada** or the **ANSI/NFPA 70 National Electrical Code in the United States**.

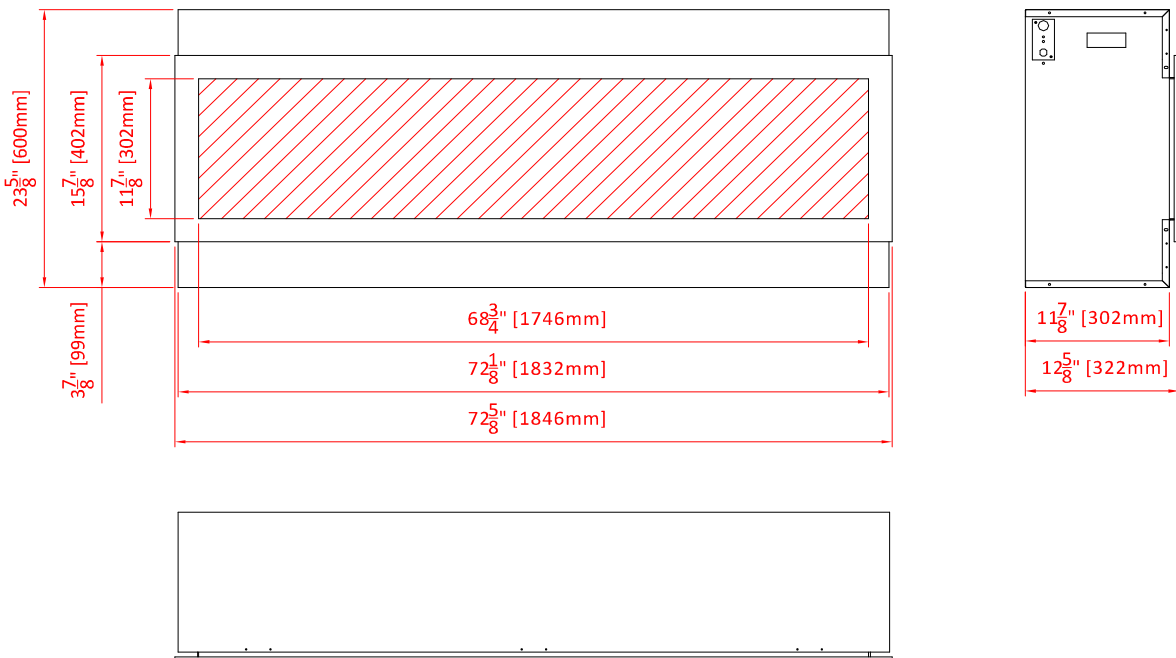

BI-88-DEEP-LUMINA (DE-190088-1)

Description	Built-in Appliance
Voltage	120V AC 60Hz
Watts	1500W Max
NO HEATER	45.2W
MOTOR HEATER	19W
Appliance Width	88 5/8" or 225.2 cm
Appliance Height	23 5/8" or 60 cm
Appliance Depth	12 5/8" or 32.2 cm
Gross Weight	195.8lbs or 89kg
Plug Location	Left side
Cord Length	70 7/8" or 180 cm
Rough Wall Opening Size	89 1/4" × 25" or 226.7 cm × 63.5 cm
BTU	5000

This appliance has been tested in accordance with the UL Standard 2021 for fixed and location dedicated electric room appliances in the United States and Canada. If you need assistance during installation, please contact your local dealer.

NOTE: This appliance must be electrically wired and grounded in accordance with local codes. In the absence of local codes, use the current **CSA C22.1 Canadian Electrical Code in Canada** or the **ANSI/NFPA 70 National Electrical Code in the United States**.

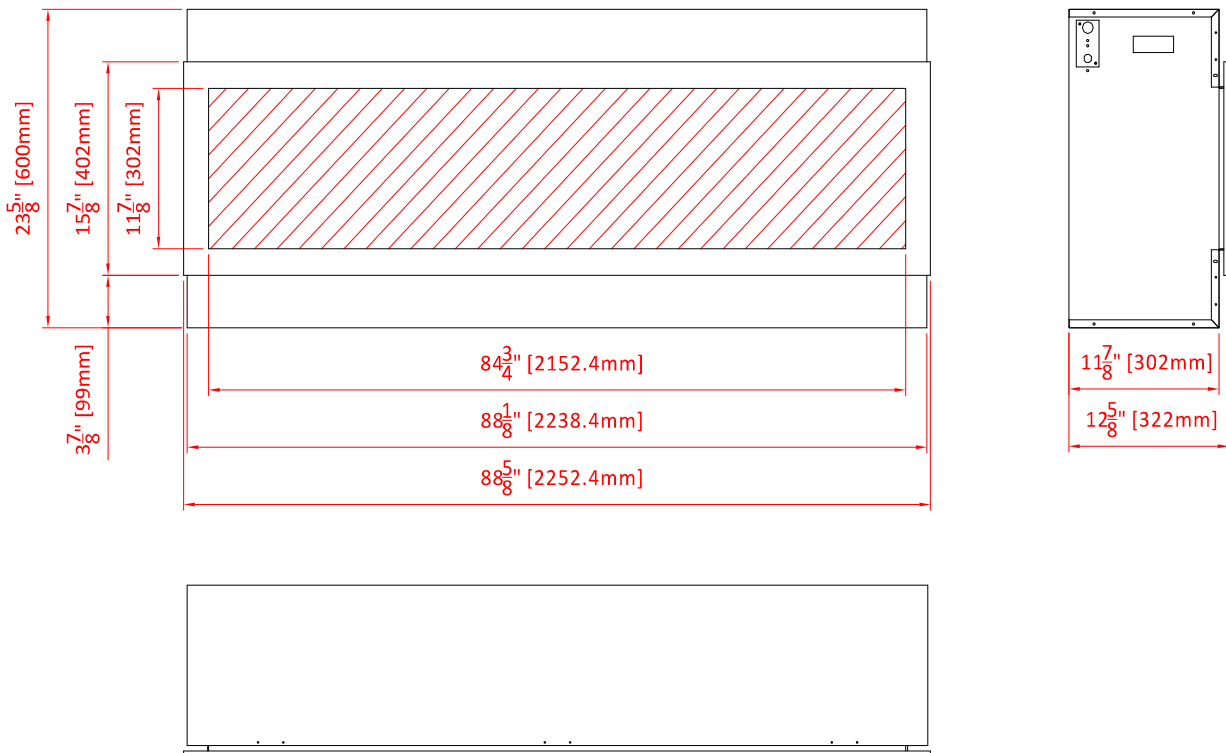

MANTEL CLEARANCE

The clearance to the mantel should be 4" minimum when a mantel is applied (Measurement is taken from the trim).

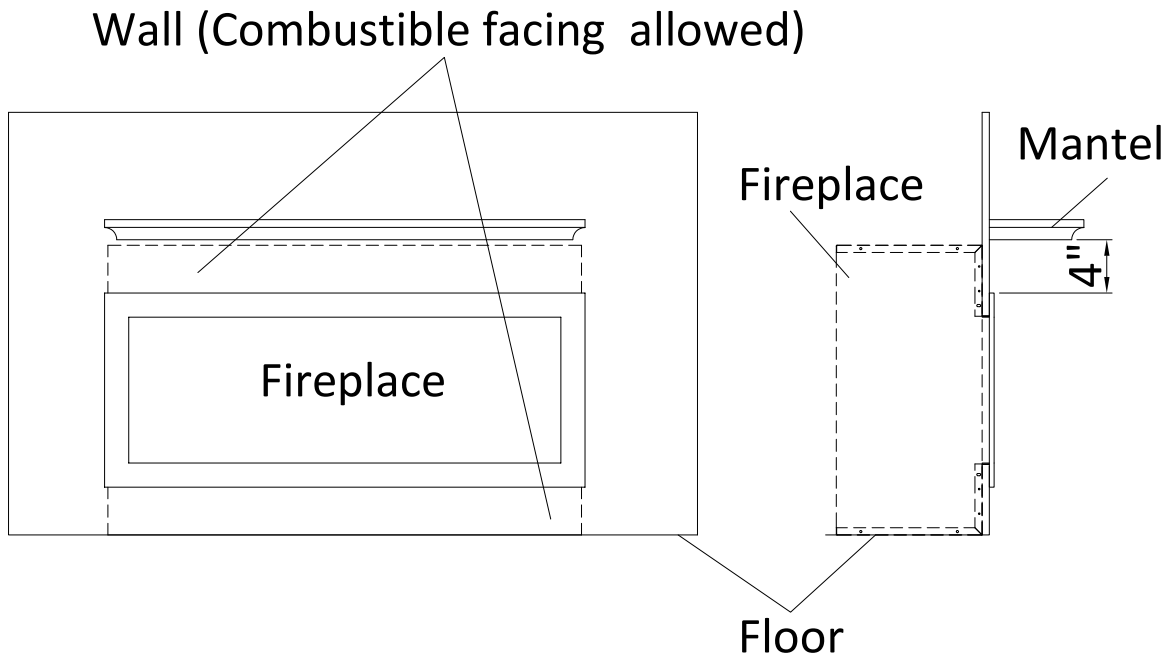

FOR BATHROOM USE

If this unit is installed in a bathroom it must be protected by a GIF receptacle or circuit. If receptacle is used it must be readily accessible.

To prevent electric shock, please be aware that this unit is an electrical appliance that is *NOT* watertight and must be installed as to prevent water from entering unit. This must be installed away from showers, tubs, etc. Never locate fireplace where it may fall into a bathtub or other water container.

All wiring connections to line power shall be in accordance with local building code requirements. Inquires about local codes and regulations must be done prior to installation.

Consult with professional electrician and adhere to all code requirements for installations in bathrooms

SAFETY DRILL SCREW AREA

There is a safety drill screw area as show below.

Please make sure that the fix screws are in this area.

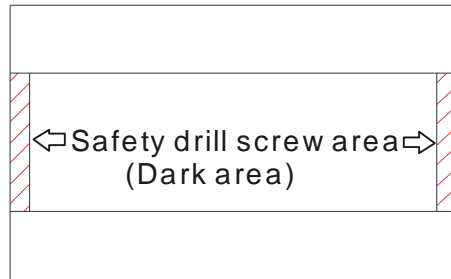

OUTDOOR INSTALLATION

Select electric fireplaces are suitable for outdoor areas protected from direct water impingement. The fireplace shall not be installed in a standalone structure, even if the following requirements are met. In addition to maintaining the listed mantel and combustible clearances, a rain protection overhang factor of 1/2 shall be constructed to the front and to each side of the installed fireplace. See illustrations below. When installed, the fireplace shall be installed on the exterior of a main structure/building. All wiring connections to line power shall be in accordance with local building code requirements.

The overhang(A) must extend at least 1/2 the roof-line height. Height is measured from the base of the fireplace.

For example: if the rood-line(B) is 8 feet above the base of the fireplace, the overhang(A) must be at 4 feet

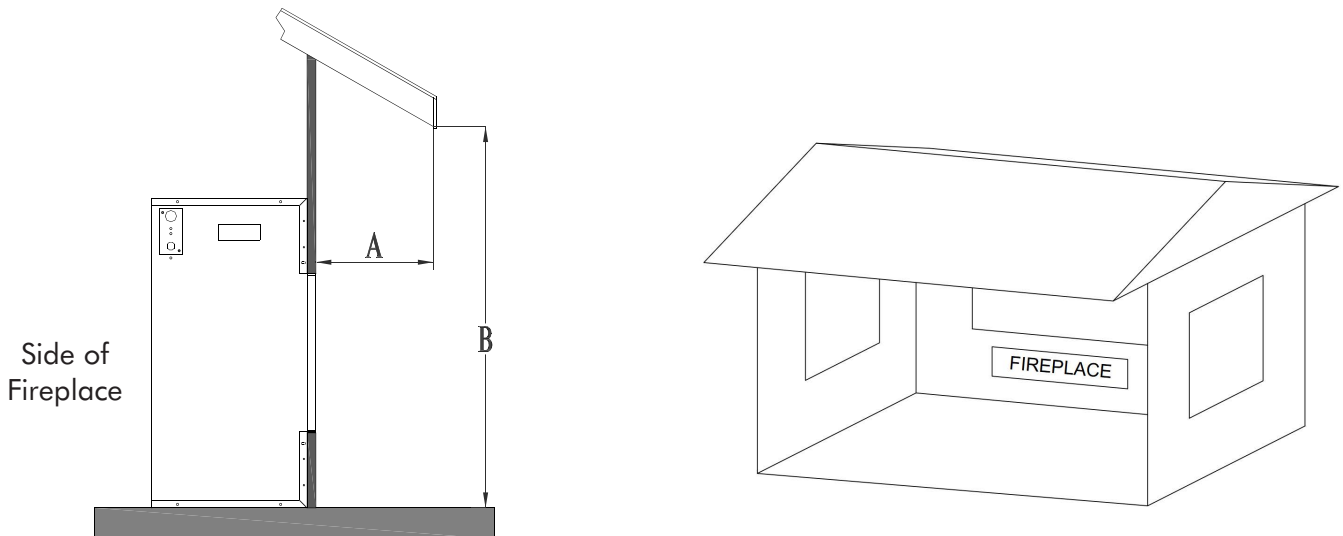

When installed in outdoor applications, it is recommended that the BI-DEEP models use the protective PAN-COVER.

INSTALLATION

NOTE: Due to the many different materials used to build walls, it is highly recommended that you consult your local builder before you install this appliance on a wall.

The models are designed to be built-in. These units allow for the finishing material (drywall, stone, tile, etc) to be built right down to the glass edge. However, that application is not always desirable or available so the surround could be used as an alternate finish option.

Important note: The optional surround is fixed with 2 screws and can be removed by unscrewing 2 screws and pulling off. It is recommended that two people remove the surround.

Preparation

1. Select a location that is not prone to moisture and is located at least 0.91m or 3 feet away from combustible materials such as curtains, drapes, furniture, bedding, paper, etc.
2. Mark the desired location on the floor and store the appliance in a safe, dry and dust free place.
3. Prepare a wall with a framed opening to accommodate the size of your unit. Leave at least 1/4" (6mm) around the edge of the appliance. Any new wiring must be done in compliance with local and national codes and other applicable regulations.

Prior to installing, test the appliance to make sure the appliance is fully operational by plugging the power supply cord into a 120 Volt grounded outlet.

The rough wall opening size of the fireplace:

	W(“)	D(“)	H(“)
BI-40-DEEP-LUMINA (DE-190040-1)	40	12	25
BI-50-DEEP-LUMINA (DE-190050-1)	50	12	25
BI-60-DEEP-LUMINA (DE-190060-1)	60	12	25
BI-72-DEEP-LUMINA (DE-190072-1)	73 1/2	12	25
BI-88-DEEP-LUMINA (DE-190088-1)	89 1/2	12	25

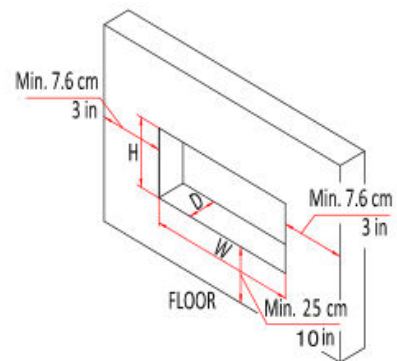

1. Take out the unit from the box. Please do the pre-test before you install the fireplace.
Pull out the optional trim from the unit as shows below.

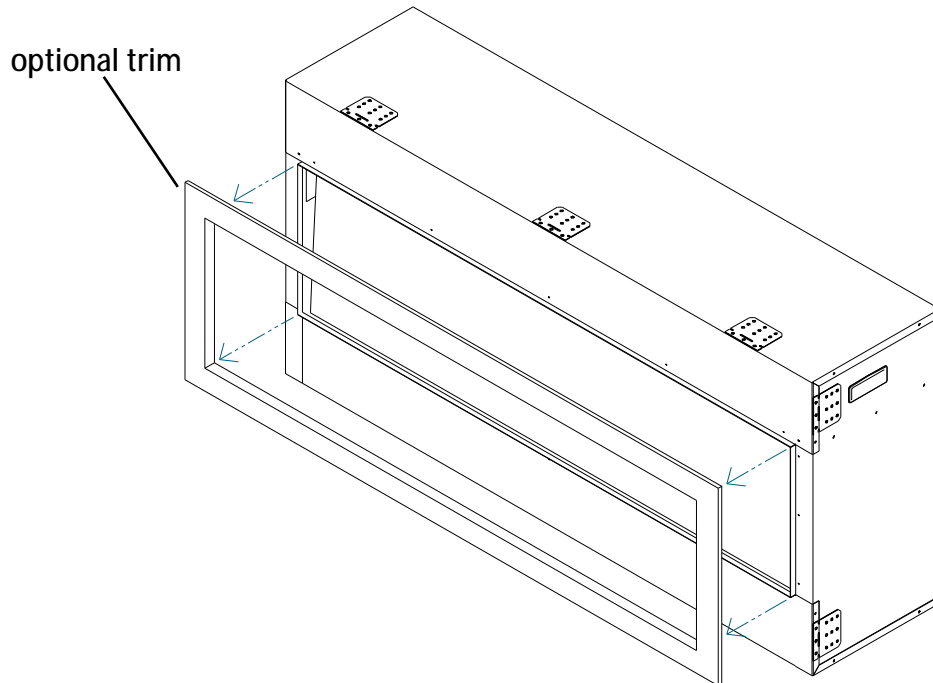

2. Remove the framing plates from the unit.

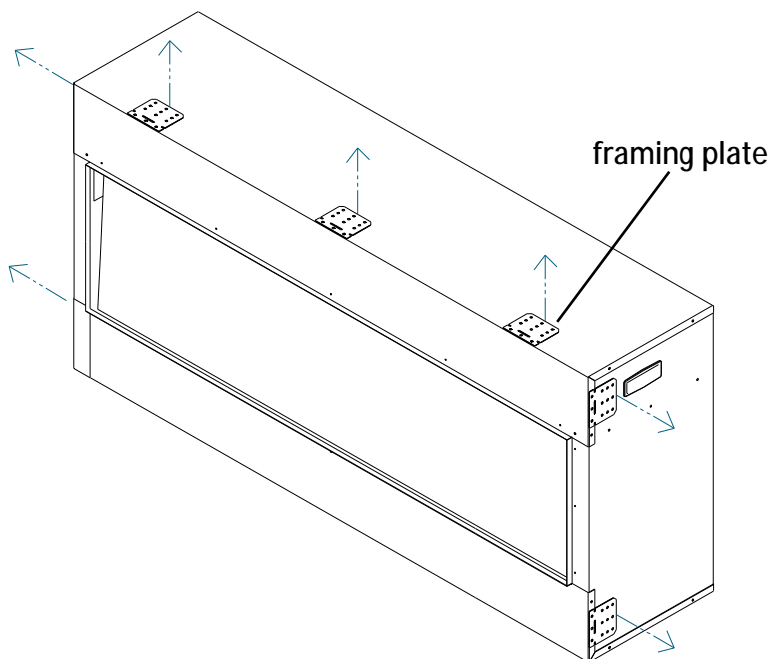

3. Re-attach the framing plates as shown in the picture.

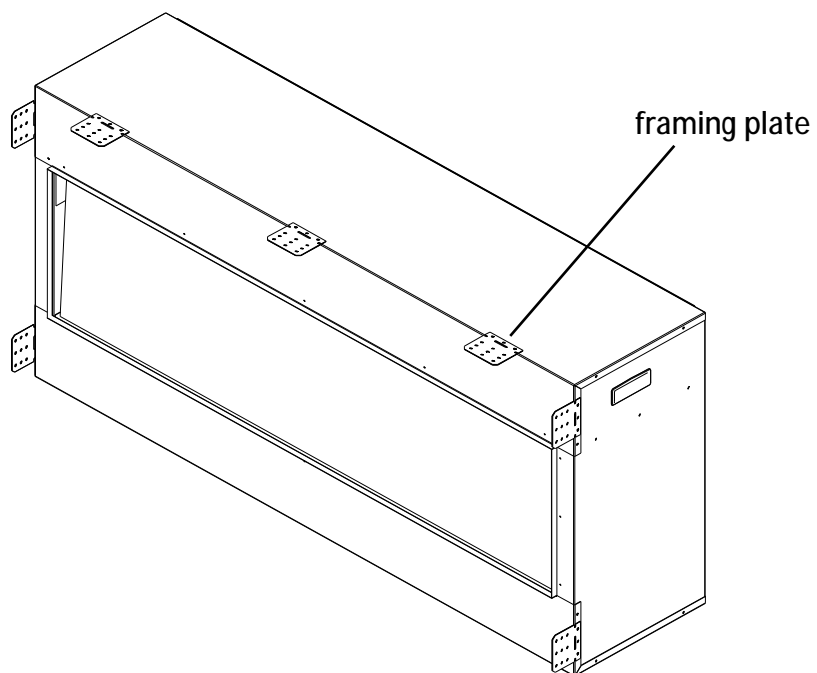

4. Bend up the framing plates.

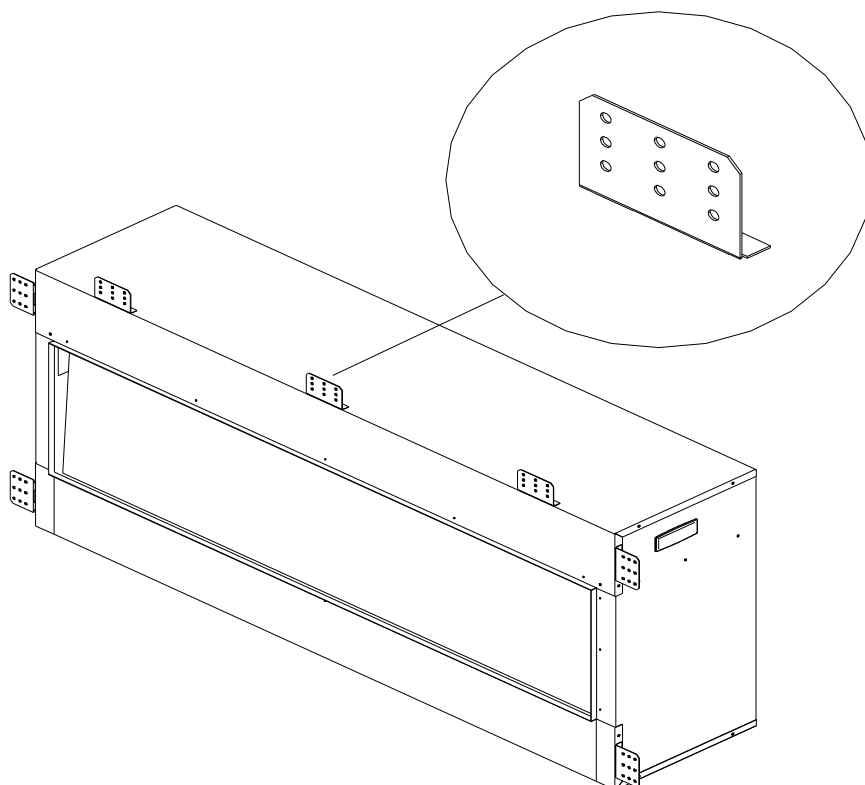

5. Put the unit into the opening.

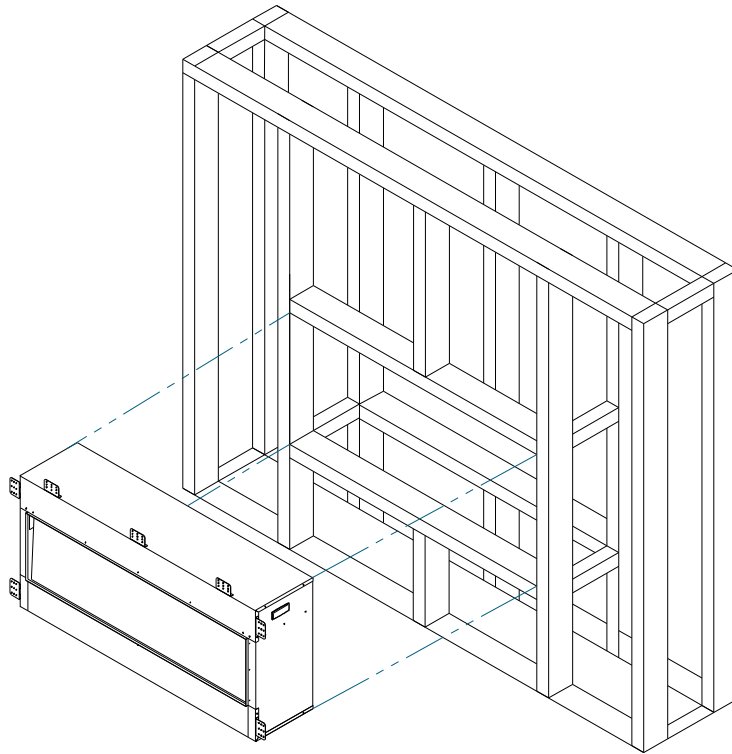

6. Drive the mounting screws into the framing plates on the unit and the wall studs.

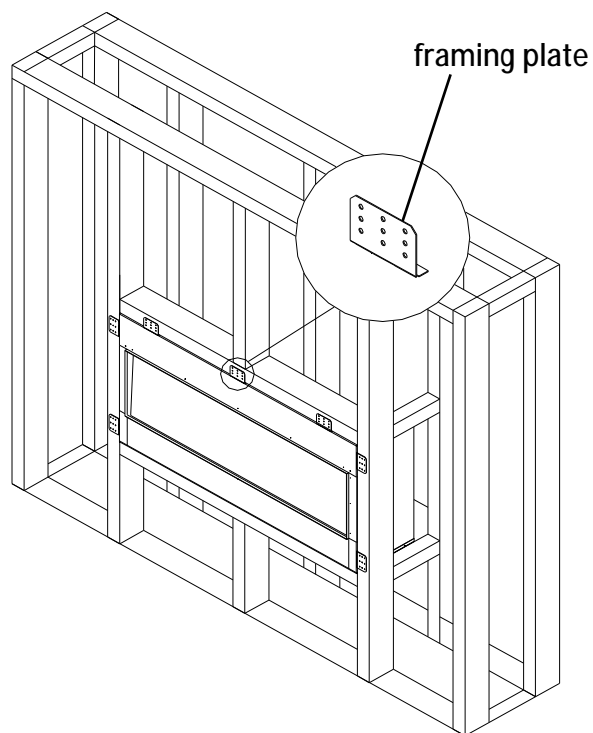

7. After checking that the fireplace operates properly, cover the glass panel with protective plastic bag and install plywood or drywall.

IMPORTANT NOTE: IF YOU WANT TO USE THE SUPPLIED SURROUND the thickness of the wall finish can only be 1”.

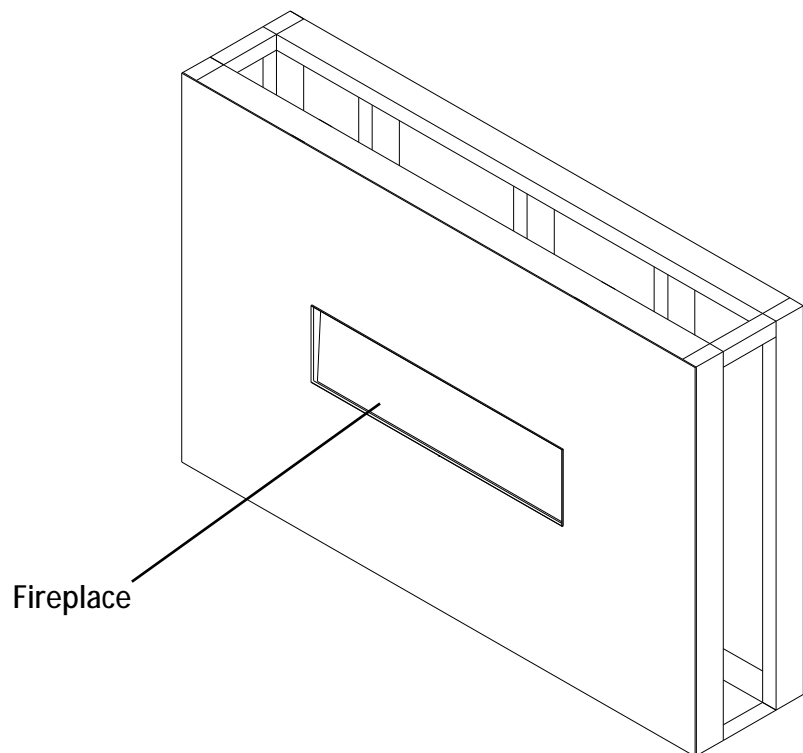

8. Decorate the plywood or drywall with glazed tile, wallpaper, etc.

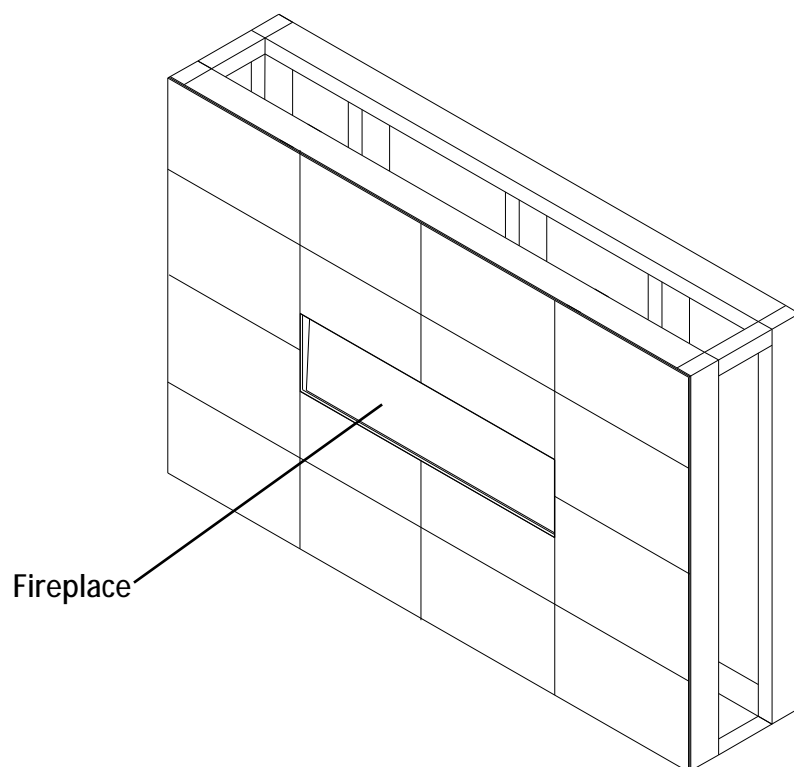

9. Put back the trim that you've removed from the unit at STEP 1.

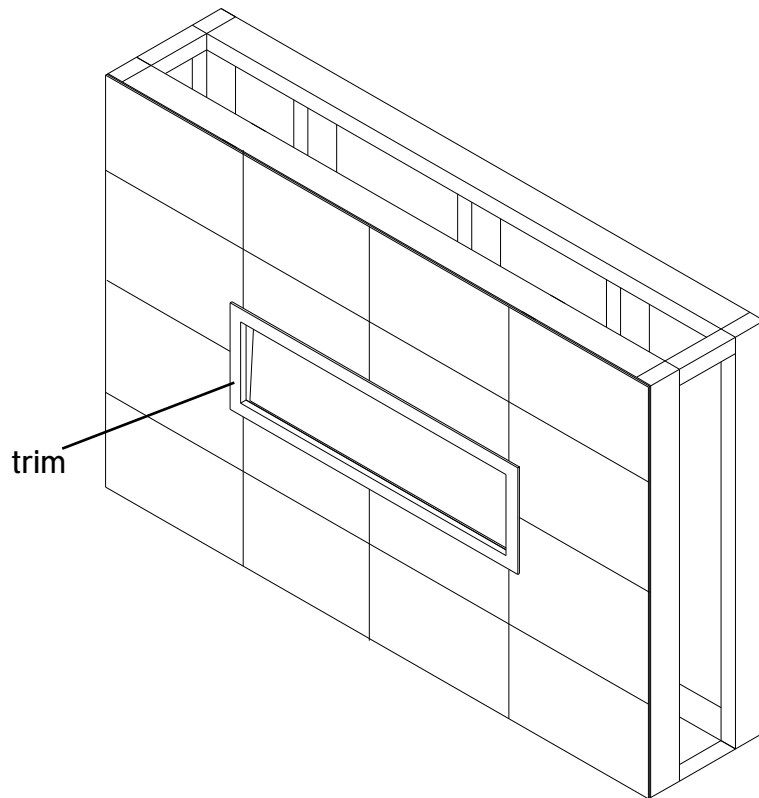

HARDWIRE INSTALLATION

Turn off the appliance completely and let cool before servicing. Only a qualified service person should service and repair this electric appliance.

If it is necessary to hardwire this appliance, a qualified electrician must remove the cord connection, and wire the appliance directly to the house hold wiring.

This appliance must be electrically connected and grounded in accordance with local codes, if hardwired. In the absence of local codes, use the current CSA C22.1 CANADIAN ELECTRICAL CODE in Canada or the current ANS/NFPA 70 NATIONAL ELECTRICAL CODE in the United States.

1. Remove the cover plate from the left side of the appliance by removing the two screws, as shown below. Unscrew and remove power cord.



2. Attach the wiring to the junction block. Please make sure the live wire goes into the "L", the neutral wire into "N" and the ground wire into "G".



3. Return the cover plate to the left side and screw the two screws back in to fasten the plate.

PANORAMA COVER INSTALLATION

Make sure install the pan-cover when the fireplace used outdoors.
Remove the cover from the packaging.

The handles will need to be attached to the cover with the provided hardware as shown in fig. 1



Fig 1

First, place a plate washer and then a spring washer on the screw as shown in fig. 2



Fig 2

Affix the handles to the front of the cover using the prepared screws. Fig. 3



Fig 3

Insert the assembled cover onto the unit as shown in Figs. 4 and 5



Fig 4



Fig 5

Media Options

The media that come with the fireplace are large glass nuggets, 3 D clear glass, clear blue & white diamond shaped media and DESIGN-MEDIA-OAK-12PCE-LG.



DESIGN-MEDIA-OAK-12PCE-LG

2. Installing the fire glass media. Pour the fire glass media into the tray as shown below. Feel free to use any combination of fire glass media that you find most appealing



Fire Glass Media-Log Installation

1. Take off the front clear glass. There is a bracket which hold the front glass. It is show as below. Unscrew the screw and take off the bracket. Turn around and insert to the gap. It can hook the glass and pull out the glass.

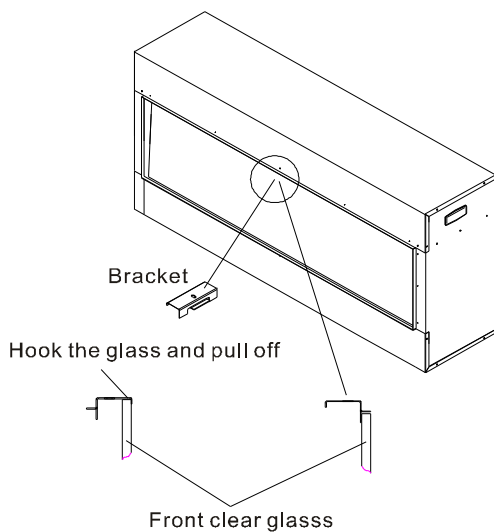

3. Put back the front glass and screw back the bracket.



OPERATION



The Fireplace operates by using either the touch panel located on the upper left hand corner or by remote control.

Plug the fireplace into a 15 Amp wall socket.

MANUAL OPERATION



1. Press  to turn on and off the fireplace.
2. Press  to adjust the flame brightness. There are 6 brightness levels (L6-L1) and an off(OFF) position. Each time the flame button is pressed, the brightness of the flame decrease.

press the flame button for 10 seconds, the timing indicator light on and will rapidly blinks, at this time, You can use the TuyaSmart APP to connect to the fireplace.
3. Press  to adjust the ember Bed /Moodlight brightness. There are 11 brightness levels (d11-d2), dynamic condition(d1) ,and the OFF(OFF) setting you can cycle through.
4. Press  to set the turn-off time, 30min-1h-2h-3h-4h-5h-6h-7h-8h-t0. The indicator light the current timing. If the timing in off position, the second press will show 30. Multiple times to set operating duration to OF, 30 min, 1h, 2h, 3h, 4h, 5h, 6h, 7h, 8h.
5. Press  or the first time to display the current setting temperature, press the button again to clear the current temperature. If the heater in off position, the second press will show 22°C (72°F). Multiple times to set ambient temperatures at 22°C (72°F), 23°C (74°F), 24°C (76°F), 25°C (78°F), 26°C (80°F), 27°C (82°F), 28°C (84°F), 15°C (52°F), 16°C (54°F), 17°C (56°F), 18°C (58°F), 19°C (60°F), 20°C (62°F), 21°C (64°F).











Temperature unit convert functionZ When the heater is on, press and hold the “” Button for 5 seconds, current temperature unit display will convert to another temperature unit.

REMOTE CONTROL OPERATION

For remote to function make sure the fireplace is plugged in and the remote has batteries.

Important: When operating the remote make sure you point the remote to the center of the fireplace. Each time you press the button, the buzzer inside the unit will beep once. It takes some time for the receiver to respond to the transmitter. Do not PRESS the buttons more than once within two seconds for correct operation.

Set the current time of the remote control

Press the  to activate the remote control and press to set  the time and date. When one of the “Sun” “Mon” “Tue” “Wed” “Thu” “Fri” “Sat” is flashing, press  or  to set the day of the week, press  to confirm day of the week and then enter hour setting. Press  or  to set the hour, press  to confirm the hour and then enter minute setting. Press  or  to set the minute and press  to confirm the minute and finish time setting.



Press this Power button to turn on and off the fireplace.







Press this Timer button to set the time to turn off the fireplace. The available settings range from 30 minutes to 8 hours. As shown in the following: 0:30 - 1:00 - 1:30 - 2:00 - 2:30 - 3:00 - 3:30 - 4:00 - 4:30 - 5:00 - 5:30 - 6:00 - 6:30 - 7:00 - 7:30 - 8:00. Once you have set the timer, the  icon will be displayed on the LCD screen of the remote control. Press this button again to cancel the timer setting and the icon disappears.



Each time the Heater Button is pressed, the power of the heater will change. As shown the following: H1- H2- AUTO (22°C) - OFF (no display)

H1 means the fireplace on Low Heat/750W.



H2 means the fireplace on High Heat/1500W.

AUTO means fireplace can automatically adjust to the temperature you set. When in AUTO, you can set the desired temperature with  or  keys. You can switch temperature between Celsius and Fahrenheit with  or  keys. When it is on Auto mode, fireplace operate at 1500W.





Press this button to adjust the speed of the flame. There are 3 options: High- Medium- Low.





Press the moodlight Button to turn the moodlight on and off. When in ON position, the display screen of the remote control shows AD1., when the number “1” flash, you can set the color with  or  key. There are 10 different colors(AD1 – 10) and dynamic condition(AD11) to choose from.











Press the ember bed Button to turn on and off the tray light. When in ON position, the LCD screen of the remote control shows 1 0 0. Press  or  or  to change the brightness of each color for tray light. When LCD screen of the remote control shows 1 1 1, the tray light is in dynamic condition and it will cycle through different colors.







Press the Flame button to turn on and off the Flame. When in ON position, the LCD screen of the remote control shows 0 1 6. Press  or  or  to change the brightness of each color flame.









7 Day Timer Function

Press  once, 7 days from Monday to Sunday will display on the LCD screen of the remote control, press  within 5 seconds to enter 7 day timer function. When “Sun” flashes, press  or  to select the day that you want to set, press  to confirm your setting. Then “ON” will be display on the LCD screen of the remote control, at the same time, digital of time hour flashes, press  or  to set the time to turn the fireplace on. After setting the startup time, “OFF” will be displayed on the LCD screen and press  or  to set the shutdown time. When the

shutdown time's set, "AUTO" will be displayed on the LCD screen of the remote control and the digital of temperature flashes. At this time, you can set the temperature by  or . Now, you have finished setting of this function.

When the 7 day timer's set, the icon  will be displayed on the LCD screen of the remote control. Press  again to cancel the 7 day timer and the icon  will disappears.

NOTE: If the 7 day timing  and the general timing  are set at the same time, the system will respond to an earlier shutdown time.

 Press Refer button to check the settings of 7 day timer. Press  or  to see the settings of the day of the week and  or  the settings of the startup and shutdown time.

WIFI OPERATION

INSTALL TuyaSmart life

There are 2 ways to install TuyaSmart;

1. Search for “TuyaSmart life” in the APP store on your phone, download and install.
2. Scan the QR code below with your mobile phone.



WIFI SETTING AND FIREPLACE OPERATION

NOTE: Make sure the Bluetooth of your phone is turned on during the following steps.

1. Create an account and log in.
2. When you log in, touch “+” (FIG.1) to enter in FIG.2. Touch “Small Home appliances” on the left side and then choose “Electric Fireplace (BLE+Wi-Fi)” to enter in FIG.3 to reset the device.

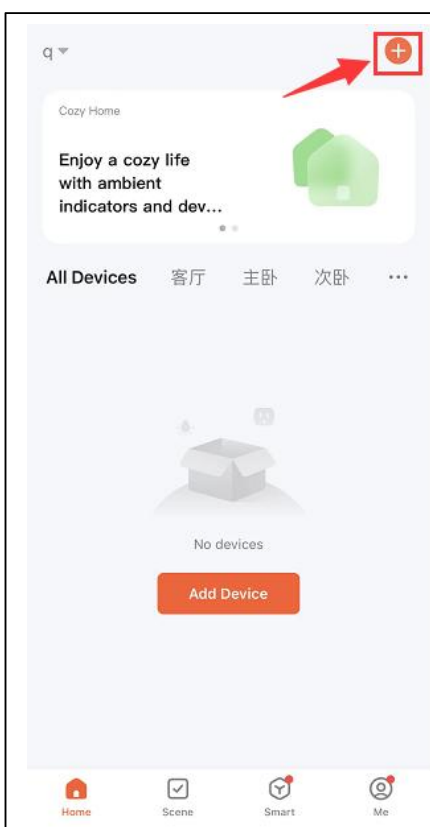

FIG.1



FIG.2



FIG.3

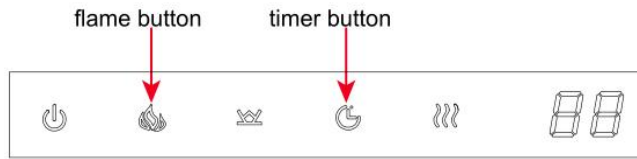

FIG.4

3. Press the flame button until the timer button flashes(FIG.4). Then confirm to go next to set your Wi-Fi account and password (FIG.5). Please make sure the Wi-Fi account and password you set are correct and Wi-Fi signal is good.
4. The APP will search and recommend the devices automatically (FIG.6) for you to add to.
5. Touch “Done” to finish Wi-Fi setting. (FIG.7)

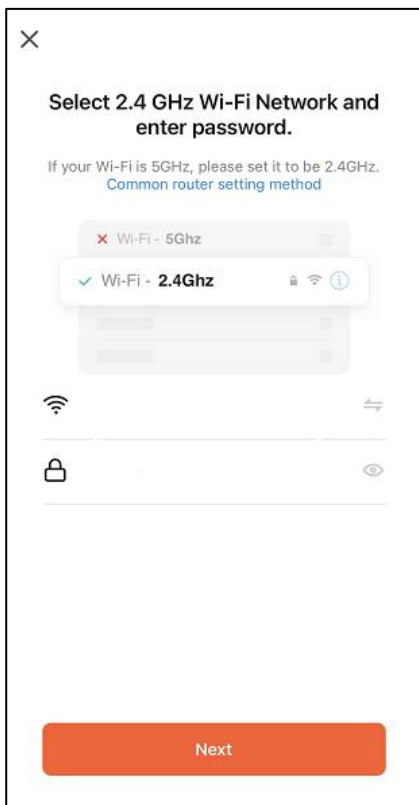

FIG.5

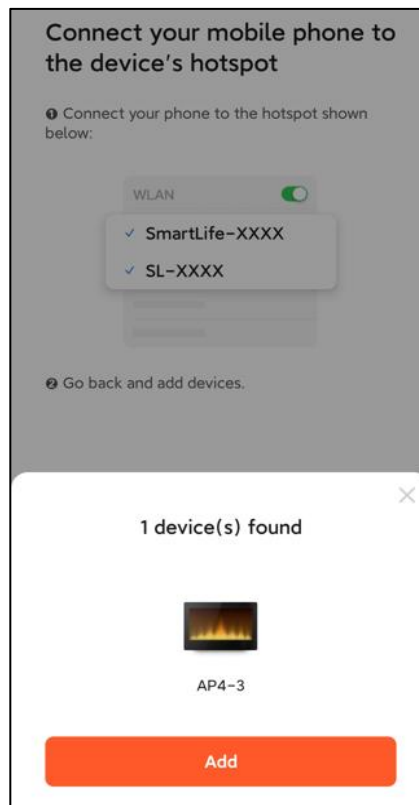

FIG.6

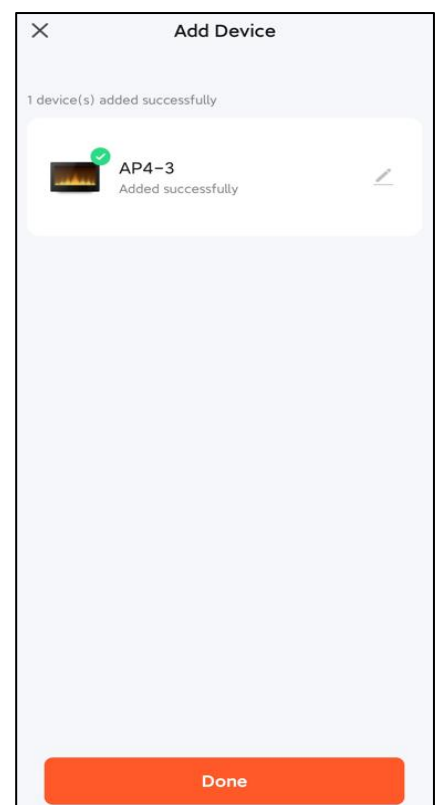

FIG.7

6. Now you are in the interface like FIG.8. You can operate the fireplace via Wi-Fi (FIG.8/ FIG.9/ FIG.10/ FIG.11).

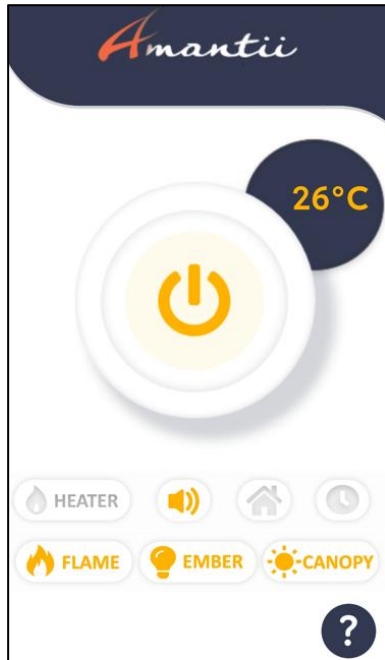

FIG.8

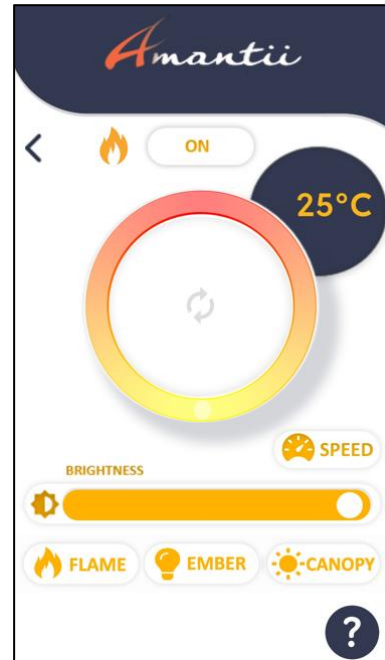

FIG.9

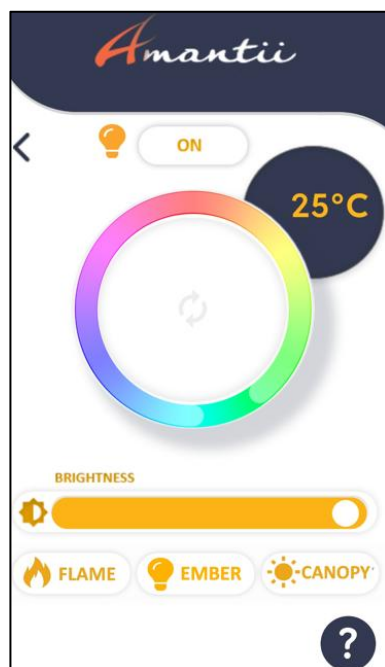

FIG.10

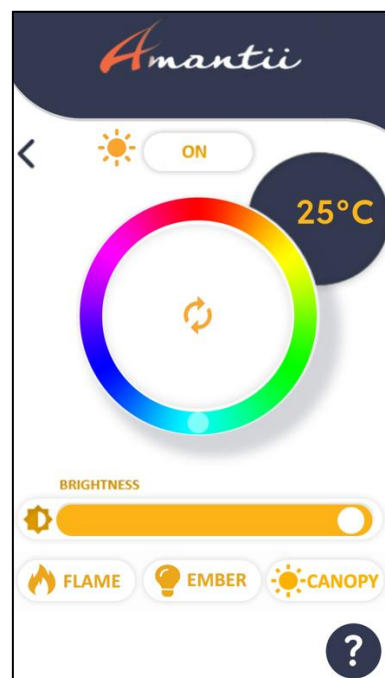
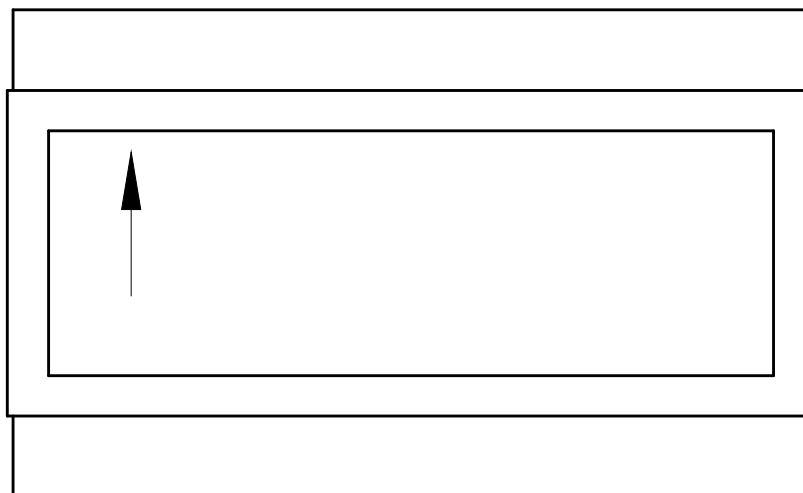

FIG.11

REPLACEMENT PARTS

There is a QR code where the arrow is marked in below image (The QR code is on the left top behind the front glass). Scan the code to get the replacement parts list for your reference. You will get a detailed parts list with images.



***There is a QR code in page 2 of the manual, at the bottom of the table of contents.**

EXPLODED VIEW

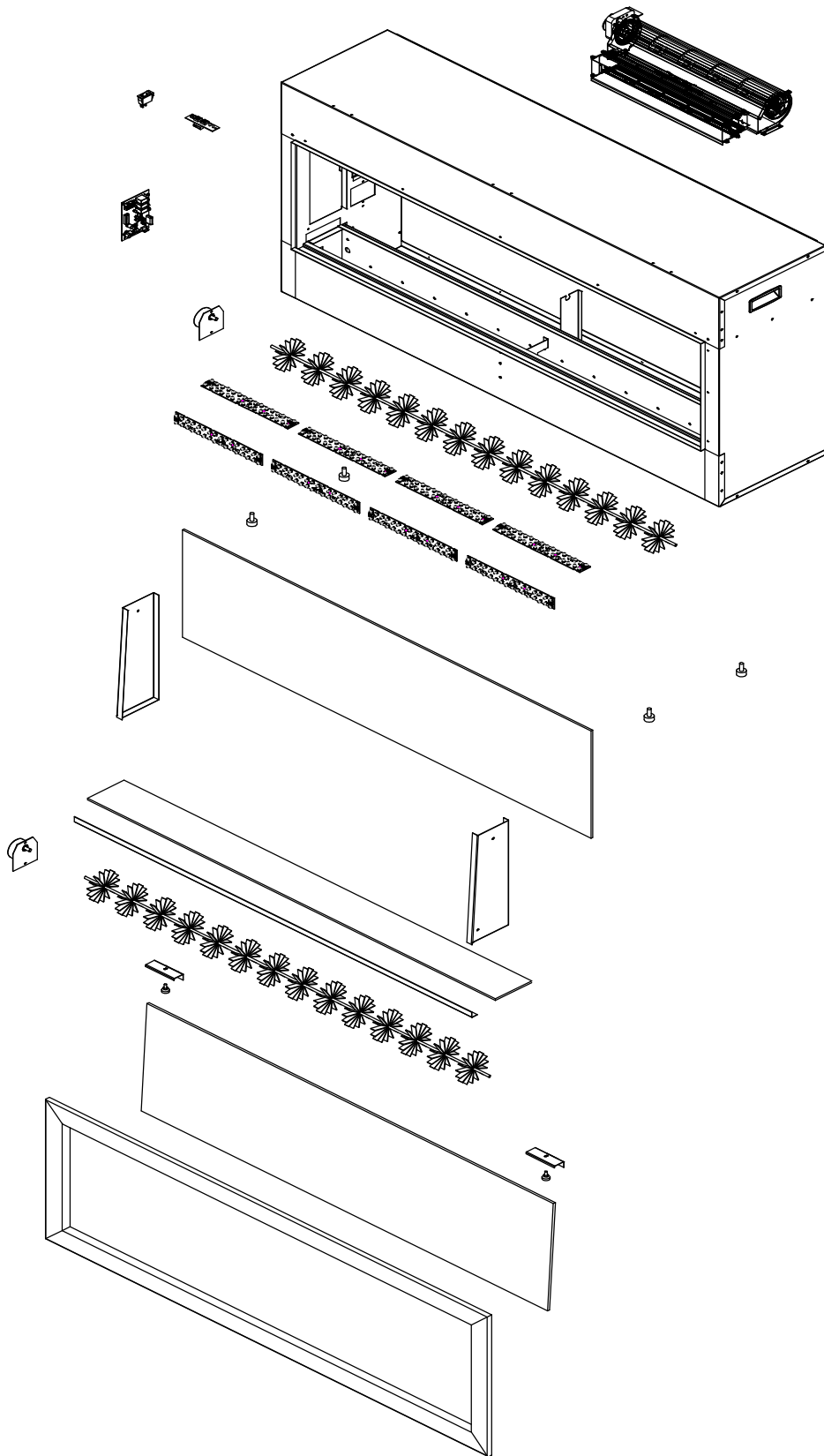

TROUBLE SHOOTING

PROBLEM	POSSIBLE CAUSE	SOLUTION
Dim or no flame	Flame LED's are burnt out	Inspect the LED's and replace them if necessary.
Ember bed is not glowing or dimming	Ember LED's are burnt out	Inspect the ember bed LED's and replace them if necessary.
Appliance turns off and will not turn on	Appliance has overheated and safety device has caused the thermal switch to disconnect	Turn off the main switch, allow appliance to cool for 10 minutes, then turn it on.
	House circuit breaker has tripped	Reset house circuit breaker.
	Appliance's fuse has blown	Replace the fuse.
Appliance will not come on when switch is flipped to ON	Appliance is not plugged into an electrical outlet	Check plug and plug in.
	Appliance has overheated and safety device has caused the thermal switch to disconnect	Turn off the main switch, allow appliance to cool for 10 minutes, then turn it on.
	Circuit board is burnt out	Inspect the circuit board and replace it if necessary.
No warm air coming out of appliance	Heater is burnt out	Inspect the burner and heater assembly and replace it if necessary.
Flame sputters	Flame motor is defective.	Call a qualified service technician and replace flame motor.
Remote Control does not work.	Low batteries. Unit switch in "O" position.	Replace AAA batteries in remote control. Turn the switch in "I" position.
Flame is fixed.	Wiring may be loose or the flame motor may be defective.	

ELECTRIC FIREPLACE WARRANTY

FOR PRODUCTS MANUFACTURED AFTER JANUARY 1, 2016



Amantii Imports Corp. ("Amantii") warrants that your newly purchased Amantii electric fireplace is free from manufacturing and material defects for a period of two (2) years from the date of the first purchase, subject to the conditions and limitations contained below.

WARRANTY APPLICATION & EXCLUSIONS

This limited warranty applies to your newly purchased Amantii electric fireplace. The warranty is valid for purchases made in any province of Canada, any of the 50 states of the United States of America (including the District of Columbia), as well as in Australia and any country in Europe. Coverage under this limited warranty is available only to the original purchaser of the product and is non-transferable.

REPLACEMENT PARTS

Replacement parts for a unit out of warranty will have to be purchased and the purchaser is also responsible for the cost of shipping. For parts that are under warranty, there is no charge for parts or shipping. Parts will be shipped via standard mail service or added to future orders if timely. The Amantii warranty does not cover labor charges. The Amantii Warranty Form must be completed and returned.

PRODUCTS EXCLUDED FROM THIS LIMITED WARRANTY

LED lights are not covered by this limited warranty and are the sole responsibility of the owner/purchaser.

WARRANTY COVERAGE AND TERM

Products covered by this limited warranty have been tested and inspected prior to shipment and, subject to the provisions of this warranty, Amantii warrants such product to be free from defects in material and workmanship for a period of two(2) years from the date of purchase of such product.

The limited two (2) year warranty period for products also applies to any implied warranties that may exist under applicable law. Some jurisdictions do not allow limitations on how long an implied warranty lasts, so the above limitation may not apply to the purchaser.

All other warranties—expressed or implied—with respect to the product, its components and accessories or any obligation/liabilities on the part of Amantii are hereby expressly excluded.

Damage to trim kits caused by standing water is not covered under warranty. If such a situation arises, please contact our support line for assistance.

Any warranty part required will be freight collect.

WARRANTY COVERAGE AND TERM - BESPOKE SERIES

Products covered by this limited warranty have been tested and inspected prior to shipment and, subject to the provisions of this warranty, Amantii warrants such products to be free from defects in material and workmanship for a period of five (5) years from the date of the first purchase of such products.

The limited five (5) year warranty period for products also applies to any implied warranties that may exist under applicable law. Some jurisdictions do not allow limitations on how long an implied warranty lasts, so the above limitation may not apply to the purchaser.

All other warranties—expressed or implied—with respect to the product, its components and accessories or any obligation/liabilities on the part of Amantii are hereby expressly excluded.

WARRANTY COVERAGE AND TERM - SIGNATURE SERIES

The warranty for the Signature Series includes a 2-year warranty provided by Dimplex for the Opti-myst, and the Amantii electric fireplace unit is covered by Amantii Electric Fireplace which is under 2 years warranty period.

LIMITATIONS TO COVERAGE UNDER LIMITED WARRANTY

This limited warranty does not apply to products that have been repaired, except by Amantii or its authorized service representatives, or otherwise altered. This limited warranty further does not apply to defects resulting from misuse, abuse, accident, neglect, incorrect installation, improper maintenance or handling, or operation with an incorrect power source. Products made by other manufacturers, sold with the product or thereafter, are not covered by this limited warranty. The use of unauthorized components will render this warranty null and void.

PANORAMA OUTDOOR UNITS

All Panorama units that are installed outdoors or in moisture intense conditions must use the stainless steel cover. Proof of purchase of the cover is required for any warranty claims.

SERVICE UNDER LIMITED WARRANTY

Defects must be brought to the attention of Amantii Technical Support by contacting Amantii at (1.877.850.9458), or at 502-1027 Davie Street, Vancouver, BC V6E 4L2. Please have your proof of purchase, catalogue/model and serial numbers available when calling; any and all service under the limited warranty requires a proof of purchase of the product.

DEFECTS

Should a product or part covered by this limited warranty be proven to be defective, in material or workmanship, and during the two (2) year limited warranty period, Amantii will replace such defective product or part without charge. If Amantii is unable to replace such product, or if replacement is not commercially practicable or cannot be timely done, in its sole discretion Amantii may, in lieu of replacement, choose to refund the purchase price for such product or part.

ELECTRIC FIREPLACE WARRANTY

FOR PRODUCTS MANUFACTURED AFTER JANUARY 1, 2016

LIMITATIONS

In no event will Amantii, including without limitation any of its directors, officers, shareholders, employees, consultants, agents, heirs, executors, administrators and assigns, be liable to the purchaser or any third party, whether in contract in tort, or on any other basis for any indirect, special, punitive, exemplary, consequential, or incidental loss, cost or damage arising out of or in connection with the sale, maintenance, use or inability to use the product, even if Amantii, including without limitation any of its directors, officers, shareholders, employees, consultants, agents, heirs, executors, administrators and assigns, have been advised of the possibility of such losses, costs or damages, or if such losses, costs or damages are foreseeable. In no event will Amantii, including without limitation any of its directors, officers, shareholders, employees, consultants, agents, heirs, executors, administrators and assigns, be liable for any direct losses, costs or damages that exceed the purchase price of the product. Some jurisdictions do not allow the exclusion or limitation of incidental or consequential damages, so the above limitation or exclusion may not apply to the purchaser.

APPLICATION OF PROVINCIAL AND STATE LAW

This limited warranty gives you specific legal rights, and you may also have other rights which vary from jurisdiction to jurisdiction. The provisions of the United Nations Convention on Contracts for the Sale of Goods shall not apply to this limited warranty or the sale of products covered by this limited warranty.

GENERAL

Amantii reserves the right to make changes at any time without notice, in design, material, specifications, prices and the right to discontinue styles and products.

GLASS

This limited warranty does not apply to the following glass products:

Model Type	Tray Glass	Front Glass	Back Glass
Symmetry / Panorama	✓	✓	✓
Traditional (TRD)	✓	✓	✓
Tru View	✓	✓	✓
Freestand / Inserts	✓	✓	
WM - Wall Mount	✓		

EXCLUSION OF BATTERIES

Ocean carriers have set new rules designed to protect the safety of shipments while in transit. This new rule disallows the inclusion of lithium/alkaline batteries, as a result we will no longer be including batteries with the fireplace remote.

REPLACEMENT MOTORS

With the reliability of the components used in the construction of our electric fireplaces, a complimentary replacement motor will no longer be included inside the carton containing the fireplace.

Technical Support: 877.850.9458 - Ext 1
Customer Service: 877.850.9458 - Ext 5
Or email us at: cdn-service@amantii.com

