

Amantii

ELECTRIC FIREPLACES

INSTALLATION /OWNER'S MANUAL SYMMETRY-XT SERIES



SYM-34-XT (SM-T190034-1/EU2)

SYM-42-XT (SM-T190042-1/EU2)

SYM-50-XT (SM-T190050-1/EU2)

SYM-60-XT (SM-T190060-1/EU2)

SYM-74-XT (SM-T190074-1/EU2)

SYM-88-XT (SM-T190088-1/EU2)

SYM-100-XT (SM-T1900100-1/EU2)

SAFETY INFORMATION



WARNING

If the information in these instructions are not followed exactly, a fire or explosion may result causing property damage, personal injury or loss of life.

Do not store or use gasoline or other flammable vapors and liquids in the vicinity of this or any other

INSTALLER: LEAVE THIS MANUAL WITH THE APPLIANCE.

CONSUMER: RETAIN THIS MANUAL FOR FUTURE REFERENCE.



TABLE OF CONTENTS

Please read and carefully follow all of the instruction found in this manual. The instructions included here will assure that you have many years of dependable and enjoyable service from your Amantii Electric Fireplace.

IMPORTANT INSTRUCTIONS.....	3
PLUG INSTALLATION.....	4
UNPACKING AND TESTING THE APPLIANCE.....	5
LOCATING THE FIREPLACE.....	5
MANTEL CLEARANCE.....	5
SYM-34-XT (SM-T190034-1/EU2).....	6
SYM-42-XT (SM-T190042-1/EU2).....	7
SYM-50-XT (SM-T190050-1/EU2).....	8
SYM-60-XT (SM-T190060-1/EU2).....	9
SYM-74-XT (SM-T190074-1/EU2).....	10
SYM-88-XT (SM-T190088-1/EU2).....	11
SYM-100-XT (SM-T1900100-1/EU2).....	12
INSTALLATION.....	13
MEDIA OPTIONS.....	17
DECORATIVE MEDIA INSTALLATION.....	17
OPERATION.....	18
MANUAL OPERATION.....	18
REMOTE CONTROL OPERATION.....	19
WIFI OPERATION.....	22
CARE AND MAINTENANCE.....	25
REPLACEMENT PARTS.....	26
EXPLODED VIEW.....	27
TROUBLE SHOOTING.....	28
SERVICE HISTORY.....	29
WARRANTY.....	30

IMPORTANT INSTRUCTIONS

PLEASE RETAIN THIS USER GUIDE FOR FUTURE REFERENCE

When using electrical appliances, basic precautions should always be followed to reduce the risk of fire, electric shock, and injury to persons, including the following:

- 1) Read all instructions before using this fireplace
- 2) The fireplace is hot when in use. To avoid burns, do not let bare skin touch hot surfaces. Keep combustible material such as furniture, cushions, bedding, paper, clothes, curtains at least 3 feet from the front of the unit
- 3) Extreme caution is necessary when any heater is used near children and whenever the unit is left operating and unattended.
- 4) Do not operate a fireplace with a damaged cord or plug, or if the heater has malfunctioned, the fireplace has drooped or damaged in any manner
- 5) Not all fireplaces are suitable for use in bathrooms or laundry facilities. Please consult with individual product literature to confirm suitability
- 6) Do not run the cord under carpeting. Do not cover cord with throw rugs, runners or the like. Arrange the cord away from traffic area and where it will not be tripped over
- 7) Do not modify this fireplace. Use it as described in the manual. Any other use not recommended by the manufacture may cause fire, shock or injury to persons
- 8) Do not use this heater with programmer, timer, separate remote-control system or any other device that switches the heater on automatically, since a fire risk exists if the heater is covered or positioned incorrectly
- 9) Disconnect all power supply before cleaning, maintenance or relocation of the fireplace
- 10) Keep the heater clean. Do not allow any objects to enter any ventilation or exhaust opening as this may cause electric shock, fire or damage to the heater
- 11) Do not immerse the cord, plug or any part of the appliance in water or any other liquid
- 12) In order to avoid a hazard due to inadvertent resetting of the thermal cut-out, this appliance must not be supplied through an external switching device

SAVE THESE INSTRUCTIONS

CAUTION: Procedures and techniques, which, if not carefully followed, will result in damage to the equipment.

WARNING: Procedures and techniques, which, if not carefully followed, will expose the user to the risk of fire, serious injury, illness or death.

PLUG INSTALLATION

Your power cord will come separate from the unit, please locate it when unpacking your fireplace. The plug contained inside the box is predetermined at the factory and according to orders placed by authorized dealers.

Available are UK, European, Swiss & Australian plugs. Should you require any of these options please contact your dealer for purchase. You will be required to give them the correct part number as listed below.



UK plug
10103060E

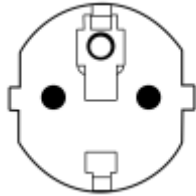

European plug
10103030E

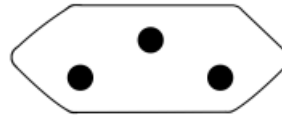

Swiss plug
10103109E

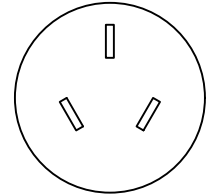

Australian plug
10103088E

Please following the instructions to correctly install the plug into your fireplace.

1. Included in the box will be a power cord similar to the one pictured below. See Picture 1.



Picture 1



Picture 2

2. Hold the male plug and insert it into the female receptacle. The receptacle is locate on the left side if the fireplace.



3. Please make sure the plugs are firmly connected. See Picture 2 above.

UNPACKING AND TESTING APPLIANCE

Carefully remove the appliance from the box.

Prior to installing the appliance, test to make sure the appliance operates properly by plugging the power supply cord into a 240 Volt grounded outlet.

Test all aspects of its operation (manual switches, remote and heater) to make sure all components are operating correctly.

As with most electronic devices, your new electric fireplace has been designed to operate at temperatures between 5 °C (41°F) and 35 °C (95°F). During the cold winter months, allow the fireplace to reach room temperature before turning it on.

NOTE: There may be trace of odor during the first few minutes of initial use. This is harmless, normal and will never occur again.

LOCATING THE FIREPLACE

Plan where to locate and frame the fireplace. This will save time and money later when you install the fireplace. Before installation consider the following:

1. Where the fireplace is located must allow for wall and ceiling clearances
2. Consider a location where the fireplace screen will not be exposed to direct sunlight from windows or doors.
3. A 15 ampere, 240 Volt, 50-60 Hz branch circuit with proper ground must be available at the location. Preferably a dedicated branch circuit should be provided to avoid circuit breakers to trip or fuses to blow.

MANTEL CLEARANCE

The clearance to the mantel should be 1/2" minimum when a mantel is applied (Measurement is taken from the trim).

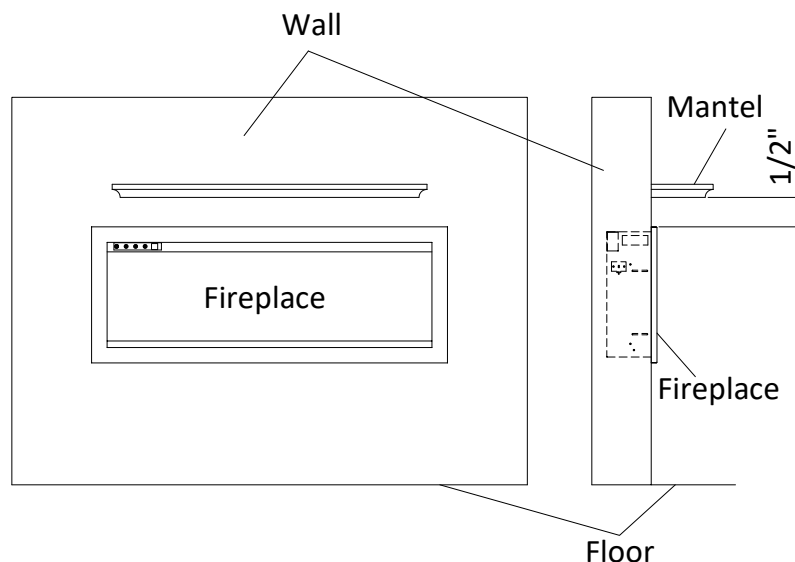

SYM-34-XT (SM-T190034-1/EU2)

Description	Built-in Appliance
Voltage	220-240V AC 50-60Hz
Watts	1500W Max
NO HEATER	15.7W Max
MOTOR HEATER	19W
Appliance Width	32 3/8" or 82.3 cm
Appliance Height	20 1/8 " or 51 cm
Appliance Depth	11 3/4" or 29.74 cm
Gross Weight	74.96 lbs or 34 kgs
Plug Location	Left side
Cord Length	70 7/8" or 180 cm
Rough Wall Opening Size	32 7/8"× 20 1/2" or 83.5 cm× 52.27 cm
BTU	5118

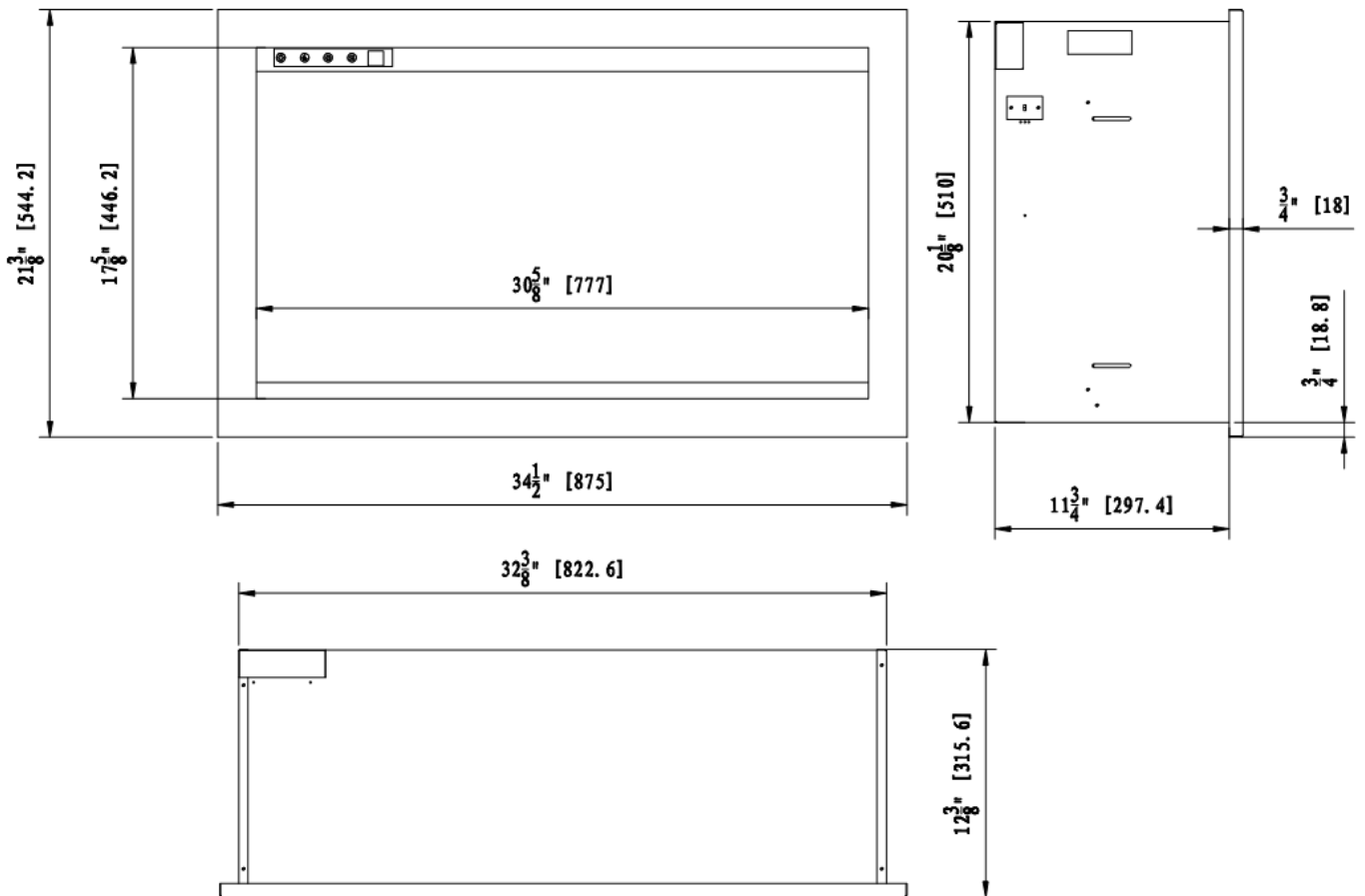

SYM-42-XT (SM-T190042-1/EU2)

Description	Built-in Appliance
Voltage	220-240V AC 50-60Hz
Watts	1500W Max
NO HEATER	20.5W Max
MOTOR HEATER	19W
Appliance Width	42 1/4" or 107.2 cm
Appliance Height	20 1/8 " or 51 cm
Appliance Depth	11 3/4" or 29.74 cm
Gross Weight	94.8 lbs or 43 kgs
Plug Location	Left side
Cord Length	70 7/8" or 180 cm
Rough Wall Opening Size	42 3/4"× 20 1/2" or 108.59 cm× 52.27 cm
BTU	5118

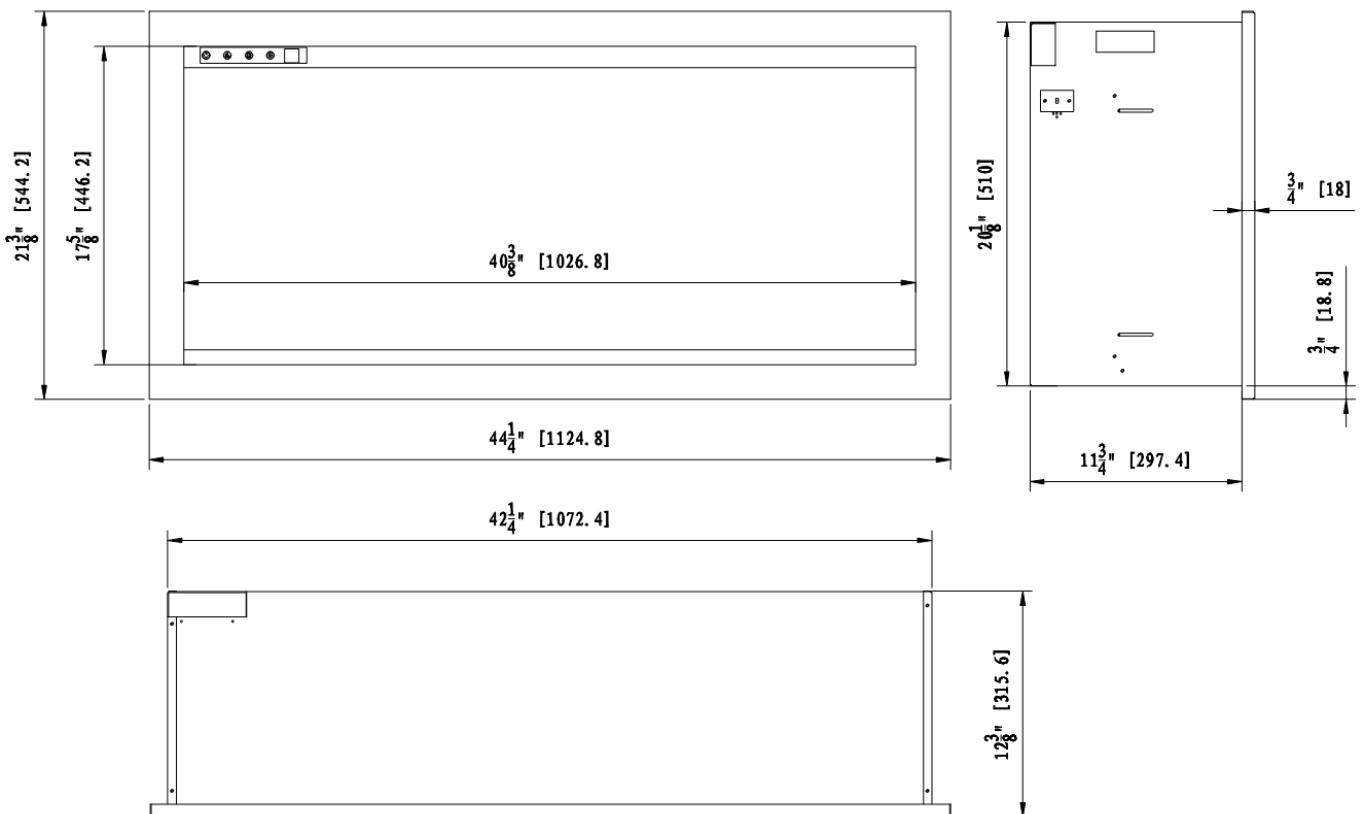

SYM-50-XT (SM-T190050-1/EU2)

Description	Built-in Appliance
Voltage	220-240V AC 50-60Hz
Watts	1500W Max
NO HEATER	24.5W Max
MOTOR HEATER	19W
Appliance Width	50 1/4" or 127.6 cm
Appliance Height	20 1/8 " or 51 cm
Appliance Depth	11 3/4" or 29.74 cm
Gross Weight	108.03 lbs or 49 kgs
Plug Location	Left side
Cord Length	70 7/8" or 180 cm
Rough Wall Opening Size	50 3/4"× 20 1/2" or 128.9 cm× 52.27 cm
BTU	5118

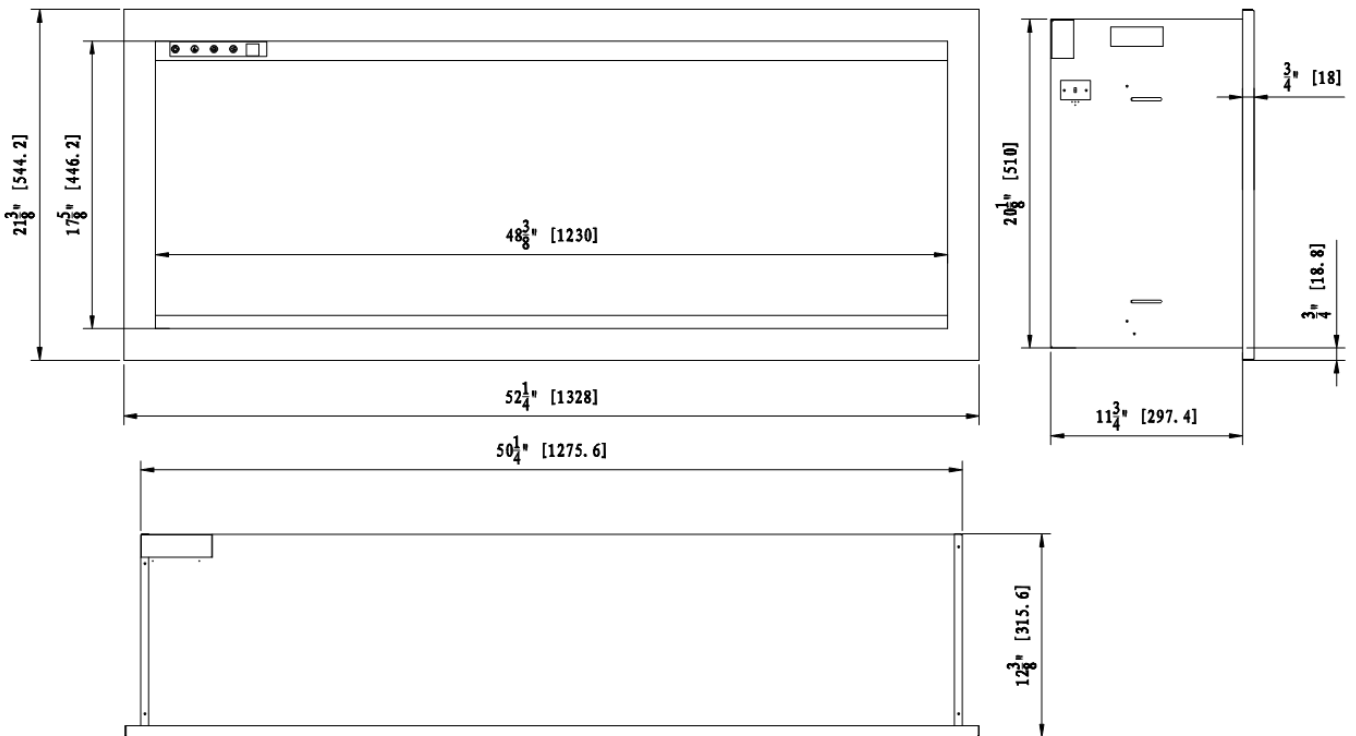

SYM-60-XT (SM-T190060-1/EU2)

Description	Built-in Appliance
Voltage	220-240V AC 50-60Hz
Watts	1500W Max
NO HEATER	25.7W Max
MOTOR HEATER	19W
Appliance Width	60 1/4" or 153 cm
Appliance Height	20 1/8 " or 51 cm
Appliance Depth	11 3/4" or 29.74 cm
Gross Weight	127.87 lbs or 58 kgs
Plug Location	Left side
Cord Length	70 7/8" or 180 cm
Rough Wall Opening Size	60 3/4"× 20 1/2" or 151.88 cm× 52.27 cm
BTU	5118

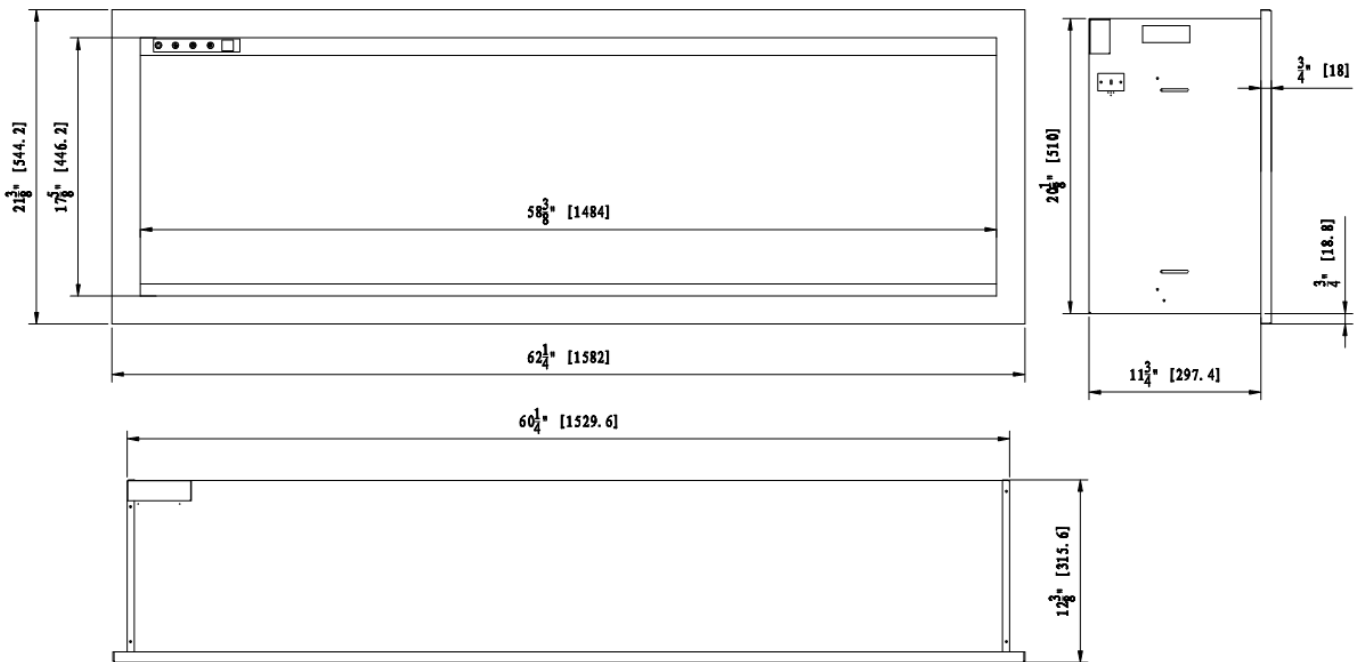

SYM-74-XT (SM-T190074-1/EU2)

Description	Built-in Appliance
Voltage	220-240V AC 50-60Hz
Watts	1500W Max
NO HEATER	28W Max
MOTOR HEATER	19W
Appliance Width	74 1/4" or 188.5 cm
Appliance Height	20 1/8 " or 51 cm
Appliance Depth	11 3/4" or 29.74 cm
Gross Weight	156.53 lbs or 71 kgs
Plug Location	Left side
Cord Length	70 7/8" or 180 cm
Rough Wall Opening Size	74 3/4"× 20 1/2" or 189.87 cm× 52.27 cm
BTU	5118

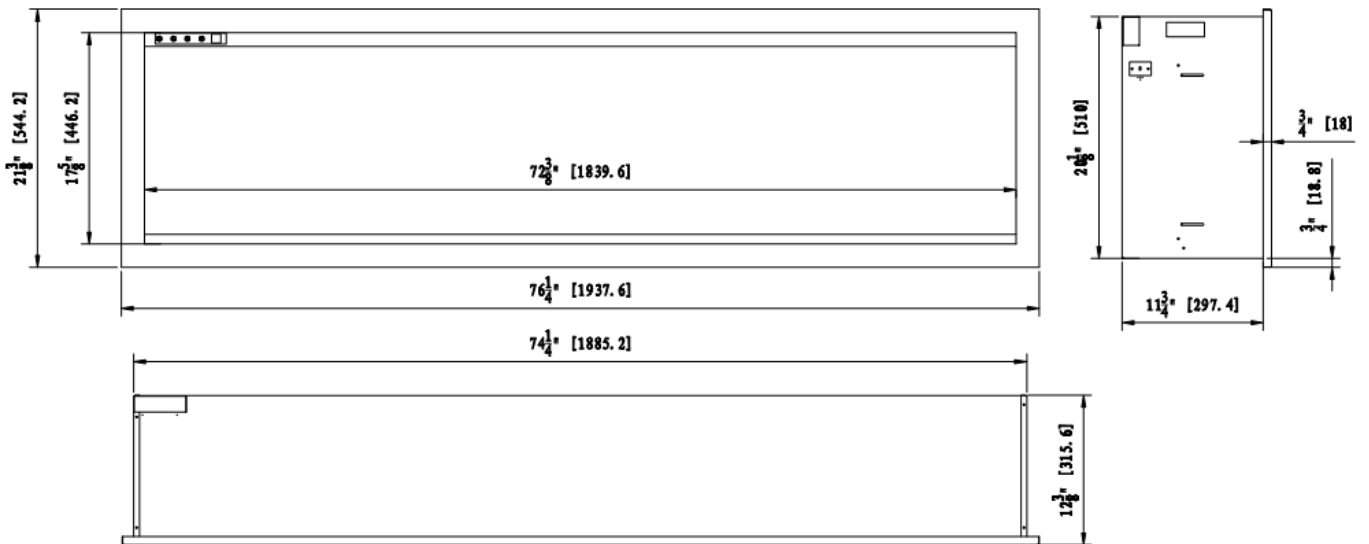

SYM-88-XT (SM-T190088-1/EU2)

Description	Built-in Appliance
Voltage	220-240V AC 50-60Hz
Watts	1500W Max
NO HEATER	30W Max
MOTOR HEATER	19W
Appliance Width	88 1/4" or 224.1 cm
Appliance Height	20 1/8 " or 51 cm
Appliance Depth	11 3/4" or 29.74 cm
Gross Weight	182.98 lbs or 83 kgs
Plug Location	Left side
Cord Length	70 7/8" or 180 cm
Rough Wall Opening Size	88 3/4"× 20 1/2" or 225.43 cm× 52.27 cm
BTU	5118

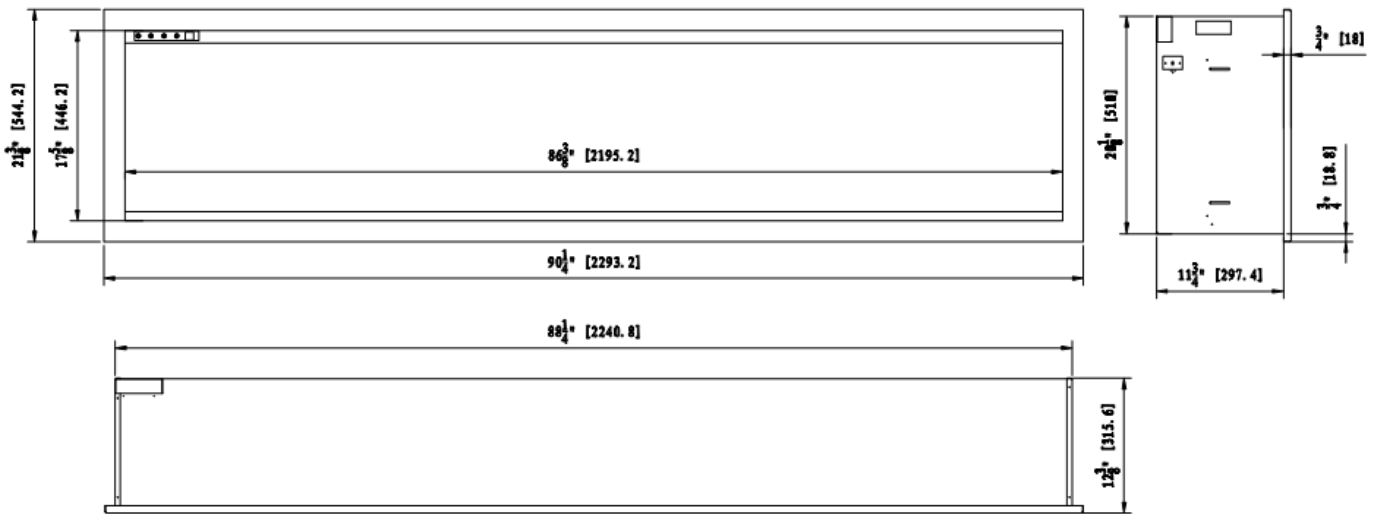

SYM-100-XT (SM-T1900100-1/EU2)

Description	Built-in Appliance
Voltage	220-240V AC 50-60Hz
Watts	1500W Max
NO HEATER	31W Max
MOTOR HEATER	19W
Appliance Width	100 1/4" or 254.6 cm
Appliance Height	20 1/8 " or 51 cm
Appliance Depth	11 3/4" or 29.74 cm
Gross Weight	205.03 lbs or 93 kgs
Plug Location	Left side
Cord Length	70 7/8" or 180 cm
Rough Wall Opening Size	100 3/4"× 20 1/2" or 255.9 cm× 52.27 cm
BTU	5118

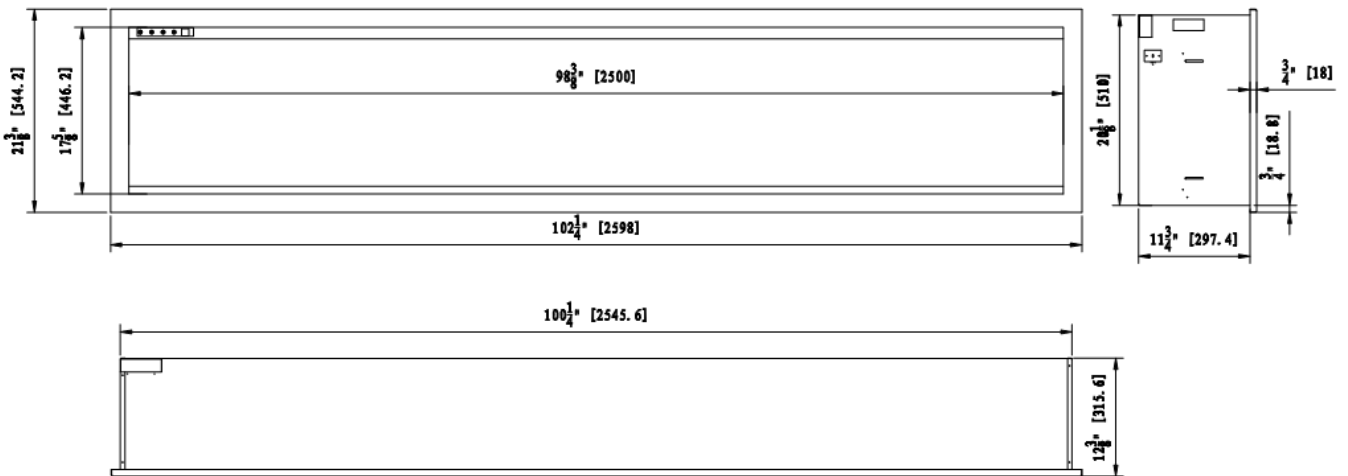

INSTALLATION- BUILT-IN

NOTE: Due to the many different materials used to build walls, it is highly recommended that you consult your local builder before you install this appliance on a wall.

Preparation

1. Select a location that is not prone to moisture and is located at least 0.91m or 3 feet away from combustible materials such as curtains, drapes, furniture, bedding, paper, etc.
2. Mark the desired location on the floor and store the appliance in a safe, dry and dust free place.
3. Prepare a wall with a framed opening to accommodate the size of your unit. Leave at least 1/4" (6mm) around the edge of the appliance. Any new wiring must be done in compliance with local and national codes and other applicable regulations.

Prior to installing, test the appliance to make sure the appliance is fully operational by plugging the power supply cord into a 240 Volt grounded outlet.

The rough wall opening size of the fireplace:

	W(")	D(")	H(")
SYM-34-XT(SM-T190034-1/EU2)	32 7/8	12 1/4	20 1/2
SYM-42-XT(SM-T190042-1/EU2)	42 3/4	12 1/4	20 1/2
SYM-50-XT(SM-T190050-1/EU2)	50 3/4	12 1/4	20 1/2
SYM-60-XT(SM-T190060-1/EU2)	60 3/4	12 1/4	20 1/2
SYM-74-XT(SM-T190074-1/EU2)	74 3/4	12 1/4	20 1/2
SYM-88-XT(SM-T190088-1/EU2)	88 3/4	12 1/4	20 1/2
SYM-100-XT(SM-T1900100-1/EU2)	100 3/4	12 1/4	20 1/2

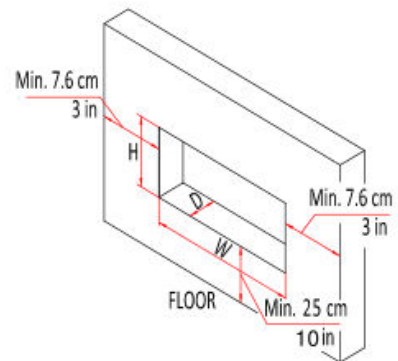

INSTALLATION

1. Unscrew 4 screws and take off the trim. (NOTE: Keep hold of the front glass as it may fall down automatically when the trim is removed.)

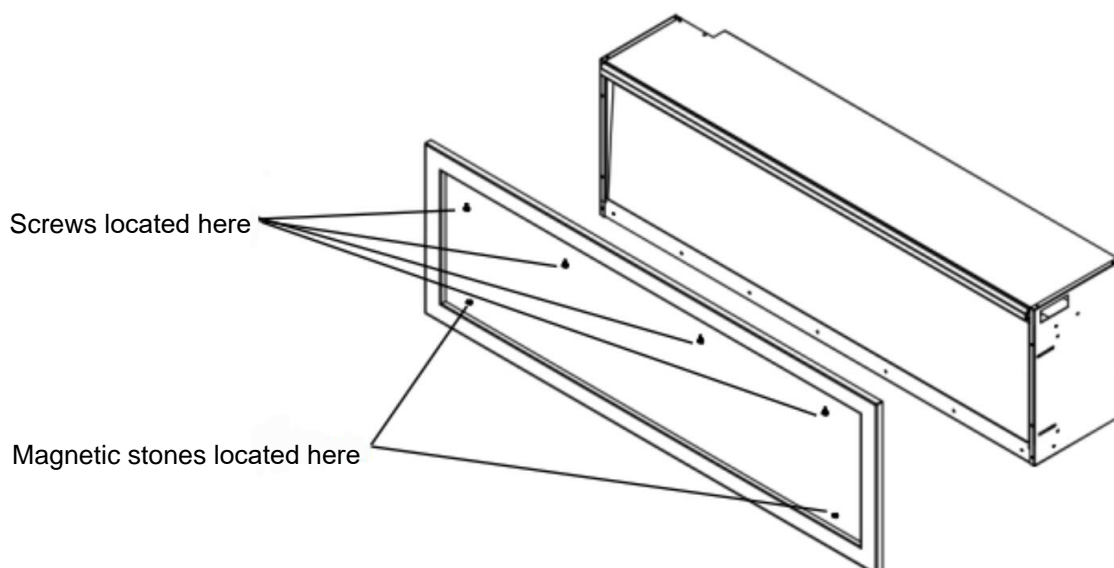

2. When the trim is removed, take off the front glass panel.

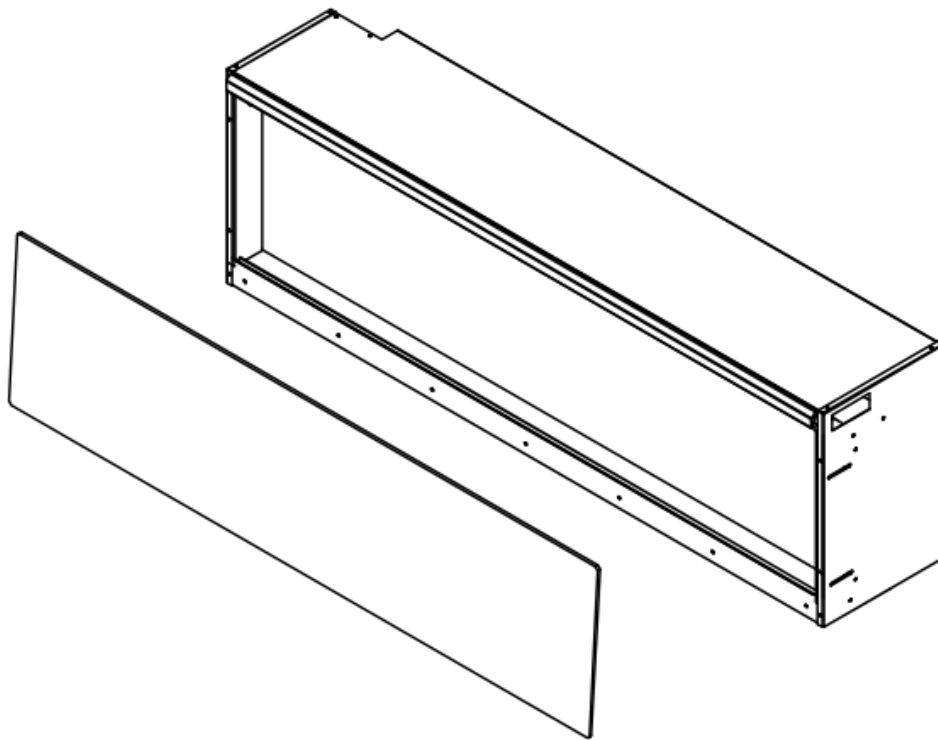

3. Unscrew the 2 screws located on each side and take off the inner side steel panels.

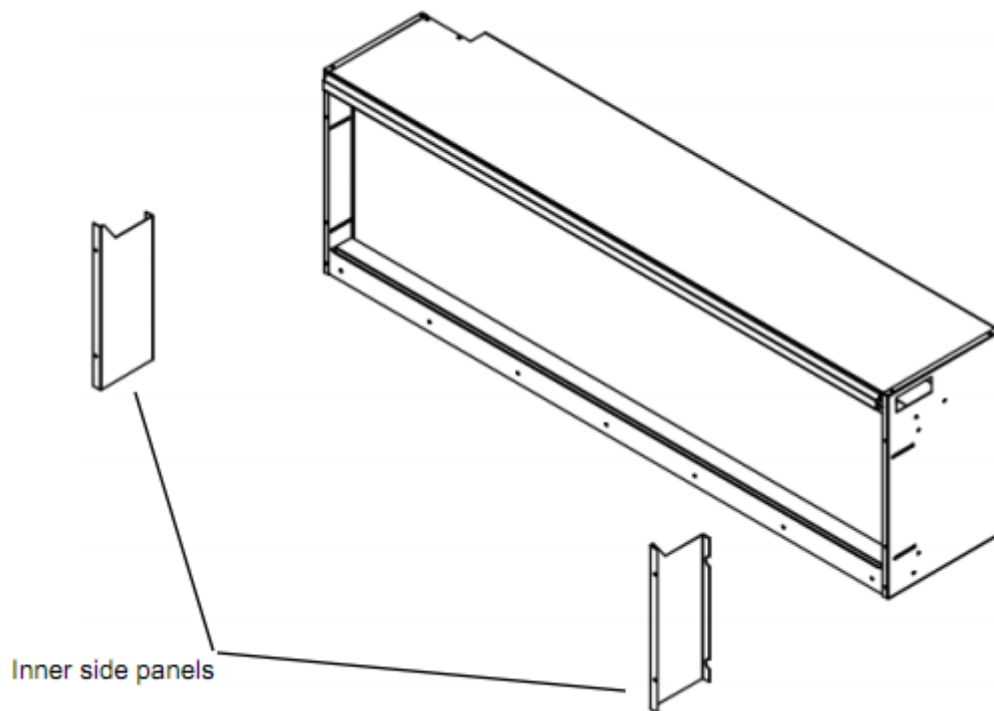

- Put the trim back onto the appliance and fasten with screws.(NOTE: This step is to make sure that the fireplace fits the wall opening well and there is no gap between the trim and the wall after installation)

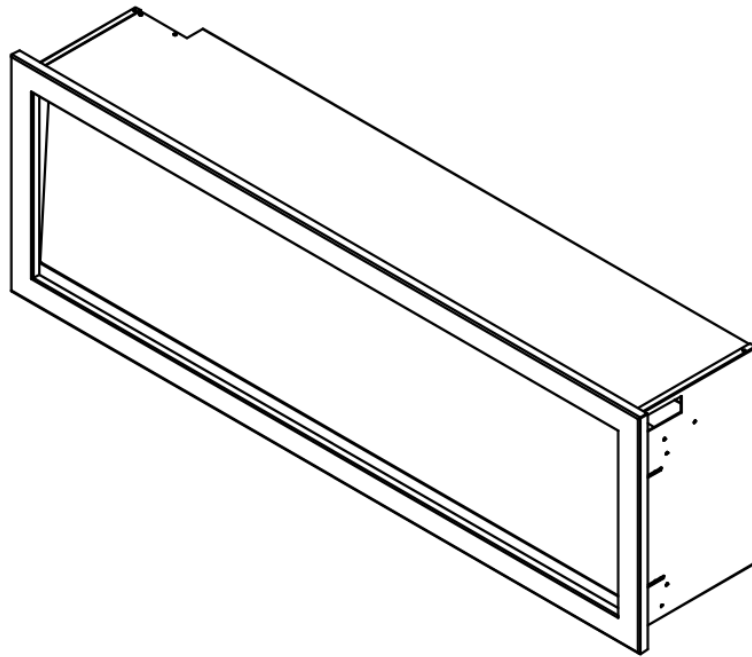

- Put the fireplace into the wall opening and fix it to the wall by screwing 2 screws each side.

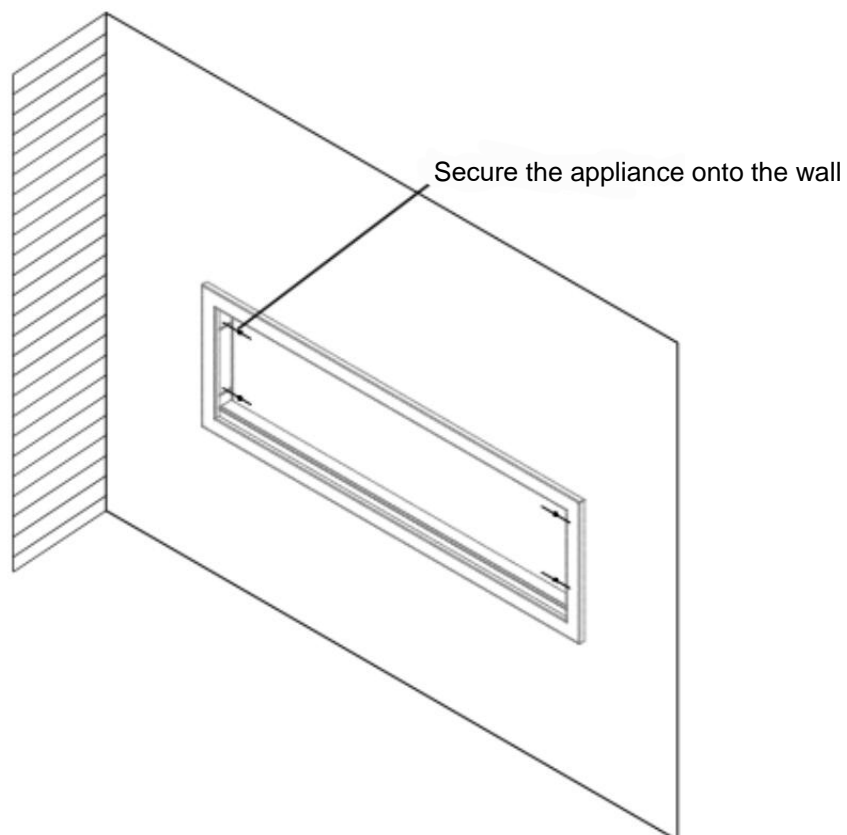

6. Remove the trim following STEP 1. Screw back the inner side steel panels.

Screw back the inner side panels
that you removed at STEP 3.

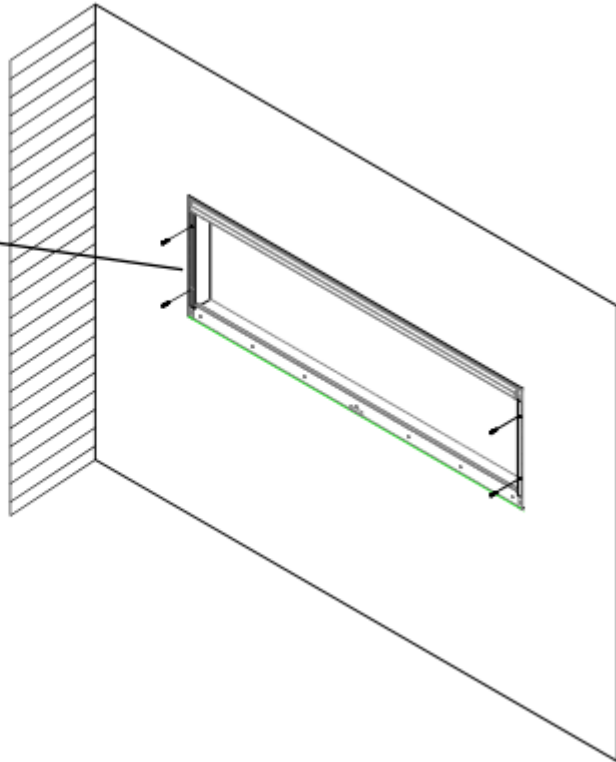

7. Put back the front glass panel and screw back the trim after you finish the media decoration.

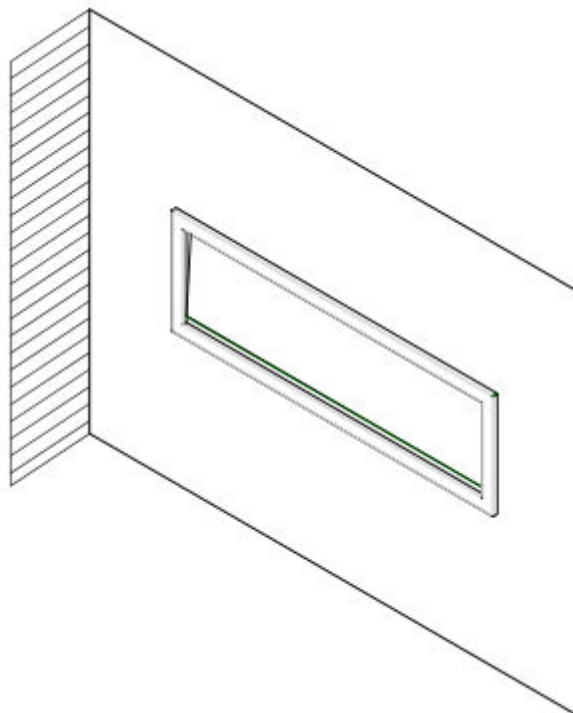

MEDIA OPTIONS

The fireplace comes with no media. Consumers may purchase optional decorative media if they choose. See dealer for more details.

DECORATIVE MEDIA INSTALLATION

Unscrew 4 screws and take off the trim. (NOTE: Keep hold of the front glass as it may fall down automatically when the trim is removed.)

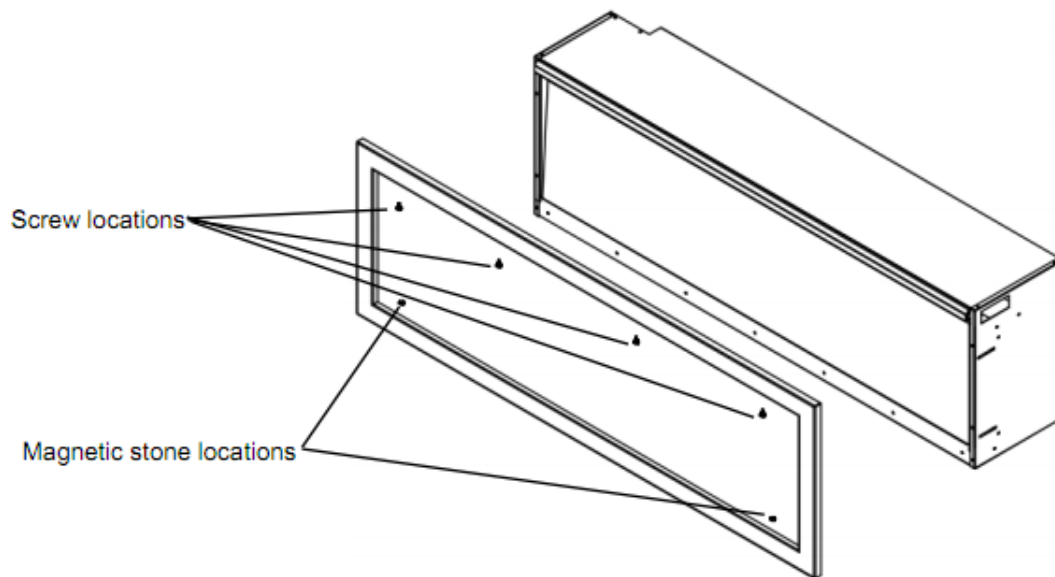

INSTALLING THE DECORATIVE MEDIA

Add your choice of decorative media into the tray. Feel free to use any combination of media including logs and/or the fire glass media that you find most appealing. Replace the glass and surround after media installation.





OPERATION



The Fireplace operates by using either the touch panel located on the upper left hand corner or by remote control.

Plug the fireplace into a 15 Amp wall socket.

MANUAL OPERATION



1. Press  to turn on and off the fireplace.
2. Press  to adjust the flame brightness. There are 6 brightness levels (L6-L1) and an off(OFF) position. Each time the flame button is pressed, the brightness of the flame decrease.

press the flame button for 10 seconds, the timing indicator light on and will rapidly blinks, at this time, You can use the TuyaSmart APP to connect to the fireplace.
3. Press  to adjust the ember Bed /Moodlight brightness. There are 11 brightness levels (d11-d2), dynamic condition(d1) ,and the OFF(OFF) setting you can cycle through.
4. Press  to set the turn-off time, 30min-1h-2h-3h-4h-5h-6h-7h-8h-t0. The indicator light the current timing. If the timing in off position, the second press will show 30. Multiple times to set operating duration to OF, 30 min, 1h, 2h, 3h, 4h, 5h, 6h, 7h, 8h.
5. Press  or the first time to display the current setting temperature , press the button again to clear the current temperature. If the heater in off position, the second press will show 22°C (72°F). Multiple times to set ambient temperatures at 22°C (72°F) , 23°C (74°F) , 24°C (76°F) , 25°C (78°F) , 26°C (80°F) , 27°C (82°F) , 28°C (84°F) , 15°C (52°F) , 16°C (54°F) , 17°C (56°F) , 18°C (58°F) , 19°C (60°F) , 20°C (62°F) , 21°C (64°F) .











Temperature unit convert functionZ When the heater is on, press and hold the “” Button for 5 seconds, current temperature unit display will convert to another temperature unit.

REMOTE CONTROL OPERATION





For remote to function make sure the fireplace is plugged in and the remote has batteries.



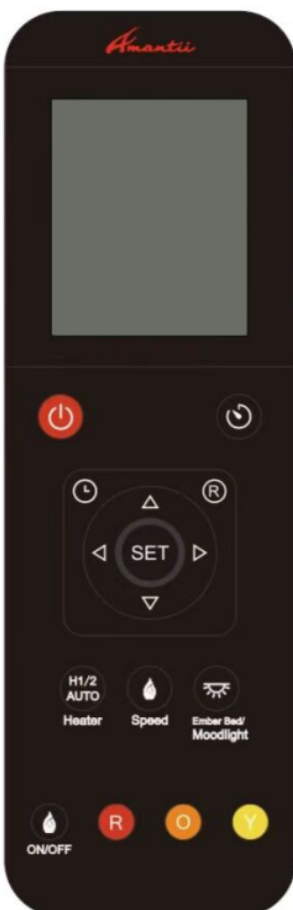

Important: When operating the remote make sure you point the remote to the center of the fireplace. Each time you press the button, the buzzer inside the unit will beep once. It takes some time for the receiver to respond to the transmitter. Do not PRESS the buttons more than once within two seconds for correct operation.

Set the current time of the remote control

Press the  to activate the remote control and press to set  the time and date. When one of the “Sun” “Mon” “Tue” “Wed” “Thu” “Fri” “Sat” is flashing, press  or  to set the day of the week, press  to confirm day of the week and then enter hour setting. Press  or  to set the hour, press  to confirm the hour and then enter minute setting. Press  or  to set the minute and press  to confirm the minute and finish time setting.





-  Press this Power button to turn on and off the fireplace.
-  Press this Timer button to set the time to turn off the fireplace. The available settings range from 30 minutes to 8 hours. As shown in the following: 0:30 - 1:00 - 1:30 - 2:00 - 2:30 - 3:00 - 3:30 - 4:00 - 4:30 - 5:00 - 5:30 - 6:00 - 6:30 - 7:00 - 7:30 - 8:00. Once you have set the timer, the  icon will be displayed on the LCD screen of the remote control. Press this button again to cancel the timer setting and the icon disappears.
-  Each time the Heater Button is pressed, the power of the heater will change. As shown the following: H1- H2- AUTO (22°C) - OFF (no display)
H1 means the fireplace on Low Heat/750W.
H2 means the fireplace on High Heat/1500W.

AUTO means fireplace can automatically adjust to the temperature you set. When in AUTO, you can set the desired temperature with  or  keys. You can switch temperature between Celsius and Fahrenheit with  or  keys. When it is on Auto mode, fireplace operate at 1500W.





Press this button to adjust the speed of the flame. There are 3 options: High- Medium- Low.













The Ember bed /moodlight Button turn the ember bed or moodlight on and off. When in on position, the display screen of the remote control shows AD1., when the number “1” flash, you can set the color with  or  keys. There are 10 different colors (AD1-10) and dynamic condition (AD11) to choose from.







Press the Flame button to turn on and off the Flame. When in ON position, the LCD screen of the remote control shows 6 6 6. Press  or  or  to change the brightness of each color flame.







7 Day Timer Function

Press  once, 7 days from Monday to Sunday will display on the LCD screen of the remote control, press  within 5 seconds to enter 7 day timer function. When “Sun” flashes, press  or  to select the day that you want to set, press  to confirm your setting. Then “ON” will be display on the LCD screen of the remote control, at the same time, digital of time hour flashes, press  or  to set the time to turn the fireplace on. After setting the startup time, “OFF” will be displayed on the LCD screen and press  or  to set the shutdown time. When the shutdown time’s set, “AUTO” will be displayed on the LCD screen of the remote control and the digital of temperature flashes. At this time, you can set the temperature by  or . Now, you have finished setting of this function.

When the 7 day timer's set, the icon  will be displayed on the LCD screen of the remote control. Press  again to cancel the 7 day timer and the icon  will disappears.

NOTE: If the 7 day timing  and the general timing  are set at the same time, the system will respond to an earlier shutdown time.

 Press Refer button to check the settings of 7 day timer. Press  or  to see the settings of the day of the week and  or  the settings of the startup and shutdown time.

WIFI OPERATION

INSTALL TuyaSmart life

There are 2 ways to install TuyaSmart;

1. Search for “TuyaSmart life” in the APP store on your phone, download and install.
2. Scan the QR code below with your mobile phone.



WIFI SETTING AND FIREPLACE OPERATION

1. Create an account and log in.
2. When you log in, touch “+” (FIG.1) to enter in FIG.2. Touch “others” on the left corner first and then choose “Connector (Wi-fi)” to enter in FIG.3 to set your Wi-fi account and password.

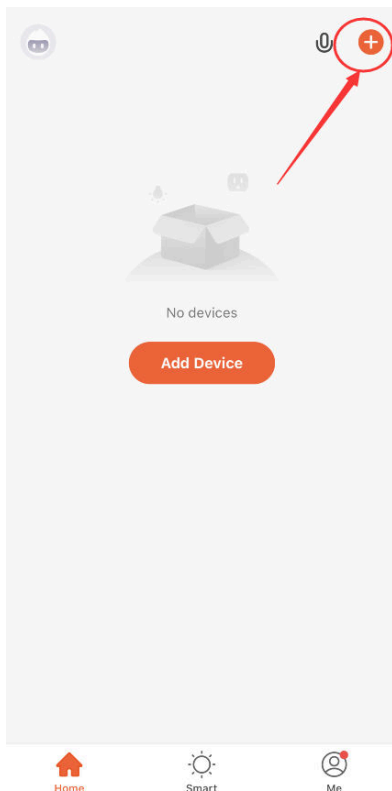

FIG.1



FIG. 2

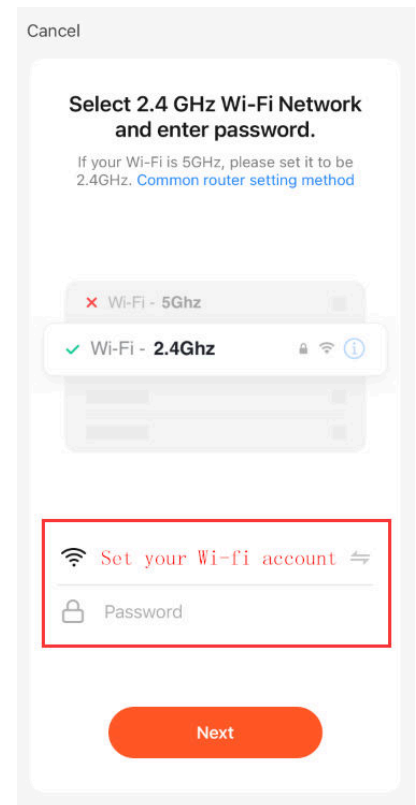



FIG.3



FIG.4

3. Press  (flame button) on the touch panel of the fireplace for more than 5 seconds when the fireplace is in standby mode. There will be 2 beeps come out from the fireplace and the  (flame button) will flash as well indicating that Wi-fi is in EZ mode. Then please confirm to go next. (FIG.5)
4. The APP will scan (FIG.6) and add the fireplace to APP (FIG.7) automatically. Please make sure the Wi-fi account and password you set are correct and Wi-fi signal is good.
5. Touch “Done” to finish Wi-fi setting.(FIG.7)

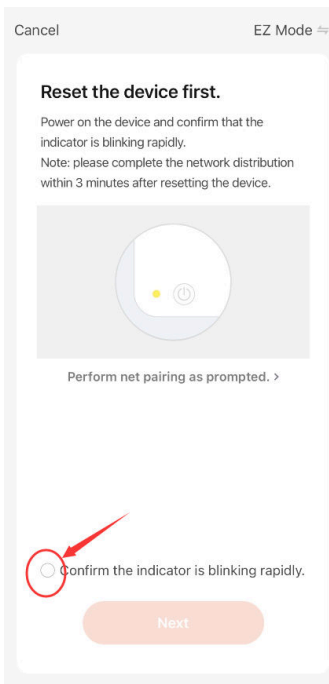

FIG.5

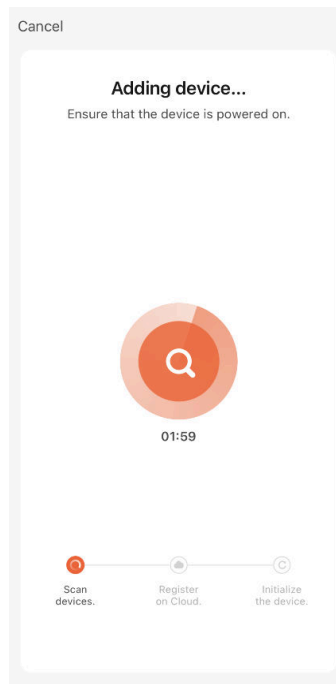

FIG.6

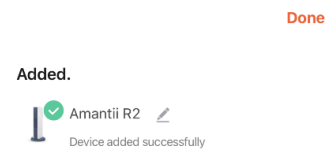

FIG.7

6. Now you are in the interface like FIG.7. You can operate the fireplace via Wi-fi.

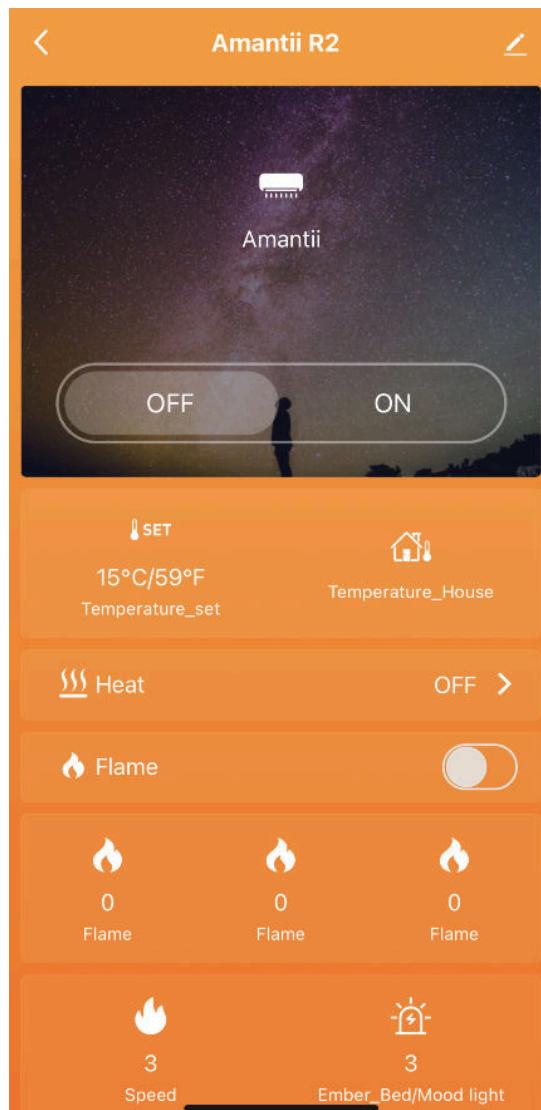

FIG.7

NOTE: Turn off the flashing blue Wifi indicator light



Touch the  (power button) once, the blue light will stop flashing.

CARE AND MAINTENANCE

1. Switch off and unplug from the power supply before cleaning.
2. Using a soft, moist cloth, with or without a mild soap solution, carefully clean the exterior surface of the products.

CAUTION: Allow the product to completely cool before handling or cleaning it.

3. Do not allow water or other liquids to run into the interior of the product, as this could create a fire and/or electrical hazard.
4. We also recommend the periodic cleaning of this appliance by lightly running a vacuum cleaner nozzle over the guards to remove any dust or dirt that may have accumulated inside or on the unit.

CAUTION: Do not use harsh detergents, chemical cleaners or solvents as they may damage the surface finish of the plastic components.

CONFORMITY WITH DIRECTIVES

Conforms to all relevant European directives



ENVIRONMENTAL PROTECTION



Recycling

This symbol is known as the 'Crossed-out Wheeie Bin Symbol'. When this symbol is marked on a product or battery, it means that it should not be disposed of with your general household waste. Some chemicals contained within electrical/electronic products or batteries can be harmful to health and the environment.

Only dispose of electrical/electronic/battery items in separate collection schemes, which cater for the recovery and recycling of materials contained within. Your co-operation is vital to ensure the success of these schemes and for the protection of the environment.

REPLACEMENT PARTS

Ref.	Description	Quantity	SYM-34-XT													
			SM-T190034-1/EU2	SM-T190042-1/EU2	SM-T190050-1/EU2	SM-T190060-1/EU2	SM-T190074-1/EU2	SM-T190088-1/EU2	SM-T190100-1/EU2	SM-T190034-1/EU2	SM-T190042-1/EU2	SM-T190050-1/EU2	SM-T190060-1/EU2	SM-T190074-1/EU2	SM-T190088-1/EU2	SM-T190100-1/EU2
1	Front Glass	1	10701365	10701366	10701367	10701368	10701369	10701370	10701371							
2	Trim	1	3207501	3208501	3209501	3210501	3211501	3212501	3213501							
3	Tray Glass	1	10702235B	10702236B	10702237B	10702238B	10702239B	10702240B	10702241B							
4	Back Glass	1	10702228	10702229	10702230	10702231	10702232	10702233	10702234							
5	LED for the Flame	Qty Required Based on Size of Unit	601144 – Qty 2	601144 – Qty 3	601144 – Qty 4	601144 – Qty 5	601144 – Qty 6	601144 – Qty 7	601144 – Qty 8							
5	LED for the Tray	Qty Required Based on Size of Unit	601136C-Qty 3	601136C-Qty 1		601136C-Qty 1	601136C-Qty 2	601136C-Qty 2	601136C-Qty 3							
6	Flame motor	1	1010501	1010501	1010501	1010501	1010501	1010501	1010501							
7	Flicker Assembly	1	3200505B	3236505	3237505	3239505	3204505B	3205505B	3206505B							
8	Fire Box	1														
9	Touch Panel	1	10124003	10124003	10124003	10124003	10124003	10124003	10124003							
10	Circuit Board	1	10124129	10124129	10124129	10124129	10124129	10124129	10124129							
11	Blower & Heater Assembly	1	602131B	602131B	602131B	602131B	602131B	602131B	602131B							
12	Temperature sensor	1	10114001B	10114001B	10114001B	10114001B	10114001B	10114001B	10114001B							
13	Signal Receiver	1	3001506B	3001506B	3001506B	3001506B	3001506B	3001506B	3001506B							
14	Remote Control	1	10105501	10105501	10105501	10105501	10105501	10105501	10105501							
15	Canopy Light	Qty Required Based on Size of Unit	601140B-Qty 1	601139B-Qty 1	601140B-Qty 1	601139B-Qty 1	601139B-Qty 1	601139B-Qty 1	601139B-Qty 1							
16	WiFi Card	1	212051	212051	212051	212051	212051	212051	212051							

*Remote Control, Canopy Light & Touch Panel are not shown in the exploded view
 *Items may not appear exactly as illustrated

EXPLODED VIEW

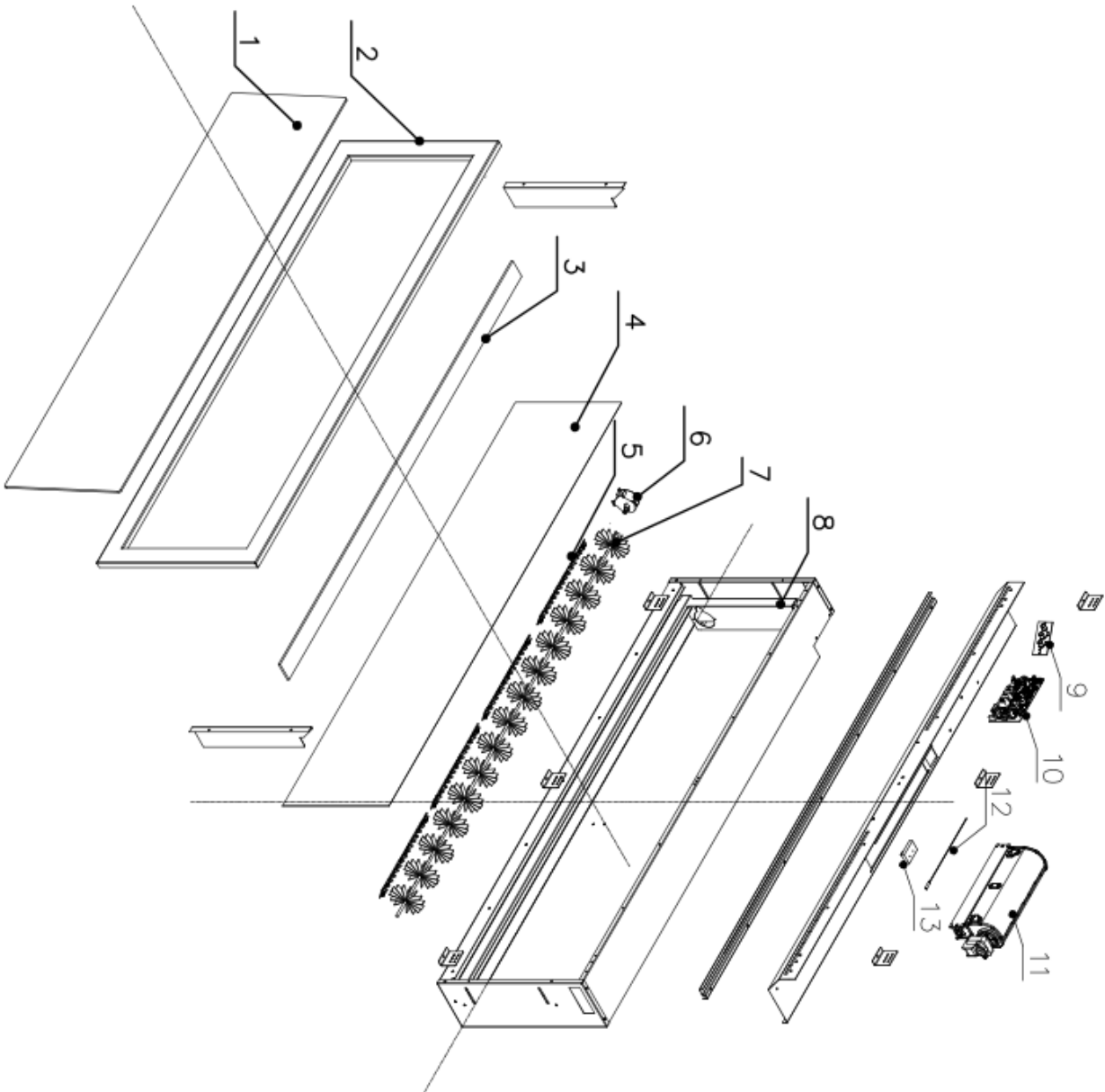

TROUBLE SHOOTING

PROBLEM	POSSIBLE CAUSE	SOLUTION
Dim or no flame	Flame LED's are burnt out	Inspect the LED's and replace them if necessary
	Back black cloth is falling off and roll the flicker	Change a new flicker and back black cloth
Ember bed is not glowing or dimming	Ember LED's are burnt out	Inspect the ember bed LED's and replace them if necessary
Appliance turns off and will not turn on	Appliance has overheated and safety device has caused the thermal switch to disconnect	Turn off the main switch, allow appliance to cool for 10 minutes, then turn it on
	House circuit breaker has tripped	Reset house circuit breaker
	Appliance's fuse has blown	Replace the fuse
Appliance will not come on when switch is flipped to ON	Appliance is not plugged into an electrical outlet	Check plug and plug in
	Appliance has overheated and safety device has caused the thermal switch to disconnect	Turn off the main switch, allow appliance to cool for 10 minutes, then turn on
	Circuit board is burnt out	Inspect the circuit board and replace if necessary
No warm air coming out of appliance	Heater is burnt out	Inspect the burner and heater assembly and replace if necessary
Flame sputters	Flame motor is defective	Call a qualified service technician and replace flame motor
Remote Control does not work	Low batteries Unit switch in "O" position	Replace AAA batteries in remote control Turn the switch in "I" position
Flame is fixed	Wiring may be loose or the flame motor may be defective	

ELECTRIC FIREPLACE WARRANTY

FOR PRODUCTS MANUFACTURED AFTER JANUARY 1, 2016



Amantii Imports Corp. ("Amantii") warrants that your newly purchased Amantii electric fireplace is free from manufacturing and material defects for a period of two (2) years from the date of the first purchase, subject to the conditions and limitations contained below.

WARRANTY APPLICATION & EXCLUSIONS

This limited warranty is applicable to your recently acquired Amantii electric fireplace, with its coverage extending to purchases made in any province of Canada, Europe, Australia, or in any of the 50 states of the United States of America, including the District of Columbia. Only the original purchaser of the product is eligible for coverage under this limited warranty, as it is non-transferable.

PRODUCTS EXCLUDED FROM THIS LIMITED WARRANTY

LED lights are not covered by this limited warranty and are the sole responsibility of the owner/purchaser.

WARRANTY COVERAGE AND TERM

Products covered by this limited warranty have been tested and inspected prior to shipment and, subject to the provisions of this warranty, Amantii warrants such products to be free from defects in material and workmanship for a period of two (2) years from the date of the first purchase of such products.

The limited two (2) year warranty period for products also applies to any implied warranties that may exist under applicable law. Some jurisdictions do not allow limitations on how long an implied warranty lasts, so the above limitation may not apply to the purchaser.

All other warranties—expressed or implied—with respect to the product, its components and accessories or any obligation/liabilities on the part of Amantii are hereby expressly excluded.

WARRANTY COVERAGE AND TERM - BESPOKE SERIES

Products covered by this limited warranty have been tested and inspected prior to shipment and, subject to the provisions of this warranty, Amantii warrants such products to be free from defects in material and workmanship for a period of five (5) years from the date of the first purchase of such products.

The limited five (5) year warranty period for products also applies to any implied warranties that may exist under applicable law. Some jurisdictions do not allow limitations on how long an implied warranty lasts, so the above limitation may not apply to the purchaser.

All other warranties—expressed or implied—with respect to the product, its components and accessories or any obligation/liabilities on the part of Amantii are hereby expressly excluded.

LIMITATIONS TO COVERAGE UNDER LIMITED WARRANTY

This limited warranty does not apply to products that have been repaired, except by Amantii or its authorized service representatives, or otherwise altered. This limited warranty further does not apply to defects resulting from misuse, abuse, accident, neglect, incorrect installation, improper maintenance or handling, or operation with an incorrect power source. Products made by other manufacturers, sold with the product or thereafter, are not covered by this limited warranty. The use of unauthorized components will render this warranty null and void.

PANORAMA OUTDOOR UNITS

All Panorama units that are installed outdoors or in moisture intense conditions must use the stainless steel cover. Proof of purchase of the cover is required for any warranty claims.

SERVICE UNDER LIMITED WARRANTY

Defects must be brought to the attention of Amantii Technical Support by contacting Amantii at (1.877.850.9458), or at 502-1027 Davie Street, Vancouver, BC V6E 4L2. Please have your proof of purchase, catalogue/model and serial numbers available when calling; any and all service under the limited warranty requires a proof of purchase of the product.

DEFECTS

Should a product or part covered by this limited warranty be proven to be defective, in material or workmanship, and during the two (2) year limited warranty period, Amantii will replace such defective product or part without charge. If Amantii is unable to replace such product, or if replacement is not commercially practicable or cannot be timely done, in its sole discretion Amantii may, in lieu of replacement, choose to refund the purchase price for such product or part.

ELECTRIC FIREPLACE WARRANTY

FOR PRODUCTS MANUFACTURED AFTER JANUARY 1, 2016

APPLICATION OF PROVINCIAL AND STATE LAW

This limited warranty gives you specific legal rights, and you may also have other rights which vary from jurisdiction to jurisdiction. The provisions of the United Nations Convention on Contracts for the Sale of Goods shall not apply to this limited warranty or the sale of products covered by this limited warranty.

GENERAL

Amantii reserves the right to make changes at any time without notice, in design, material, specifications, prices and the right to discontinue styles and products.

GLASS

This limited warranty does not apply to the following glass products:

Model Type	Tray Glass	Front Glass	Back Glass
Symmetry / Panorama	✓	✓	✓
Traditional (TRD)	✓	✓	✓
Tru View	✓	✓	✓
Freestand / Inserts	✓	✓	✓
WM - Wall Mount	✓		

EXCLUSION OF BATTERIES

Ocean carriers have set new rules designed to protect the safety of shipments while in transit. This new rule disallows the inclusion of lithium/alkaline batteries, as a result we will no longer be including batteries with the fireplace remote.

REPLACEMENT MOTORS

With the reliability of the components used in the construction of our electric fireplaces, a complimentary replacement motor will no longer be included inside the carton containing the fireplace.

Technical Support: 877.850.9458 - Ext 1

Customer Service: 877.850.9458 - Ext 5

Or email us at: cdn-service@amantii.com

ELECTRIC FIREPLACE