

01. INSTALLATION / OWNERS MANUAL



FREE STANDING



MODEL SKU:

• E50-HO

• E70-HO

SAFETY INFORMATION



WARNING

If the information in these instructions are not followed exactly, a fire or explosion may result causing property damage, personal injury or loss of life.

Do not store or use gasoline or other flammable vapors and liquids in the vicinity of this or any other.



CONSUMER: RETAIN THIS MANUAL FOR FUTURE REFERENCE.

INSTALLER: LEAVE THIS MANUAL WITH THE APPLIANCE.



WARNING: This product can expose you to chemicals including lead in the wiring, which is [are] known to the State of California to cause birth defects or other reproductive harm. For more information visit: www.p65warnings.ca.gov

Please read and carefully follow all instructions found in this manual. Please pay special attention to the safety instructions provided in this manual. The instructions included here will assure that you have many years of dependable and enjoyable service from your Amantii product.

Table of Contents

IMPORTANT INSTRUCTIONS	3
FCC CAUTIONS	4
UNPACKING AND TESTING APPLIANCE	5
GROUNDING APPLIANCE	5
CHOOSING FIREPLACE LOCATION	5
E50 HO.....	6
E70 HO.....	7
CLEARANCE	8
WIRING DIAGRAM	9
HARDWIRE INSTALLTION.....	10
MEDIA OPTIONS	14
MEDIA INSTALLATION	14
OPERATION	15
MANUAL OPERATION	15
REMOTE CONTROL OPERATION	16
WIFI OPERATION.....	19
REPLACEMENT PARTS.....	22
EXPLODED VIEW.....	24
TROUBLESHOOTING	25
SERVICE HISTORY	26
WARRANTY	27

QR Code

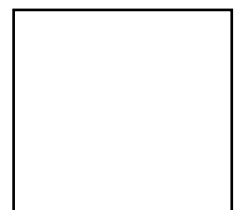

IMPORTANT INSTRUCTIONS

PLEASE RETAIN THIS USER GUIDE FOR FUTURE PREFERENCE

When using electrical appliances, basic precautions should always be followed to reduce the risk of fire, electric shock, and injury to persons, including the following:

- 1) Read all instructions before using this fireplace
- 2) The fireplace is hot when in use. To avoid burns, do not let bare skin touch hot surfaces. Keep combustible material such as furniture, cushions, bedding, paper, clothes, curtains at least 3 feet from the front of the unit
- 3) Extreme caution is necessary when any heater is used near children and whenever the unit is left operating and unattended.
- 4) Do not operate a fireplace with a damaged cord or plug, or if the heater has malfunctioned, the fireplace has dropped or damaged in any manner
- 5) Not all fireplaces are suitable for use in bathrooms or laundry facilities. Please consult with individual product literature to confirm suitability.
- 6) Do not run the cord under carpeting or cover it with rugs, runners, or similar coverings. Arrange the cord away from traffic areas and places where it could be tripped over.
- 7) Do not modify this fireplace. Use it only as described in the manual. Any other use not recommended by the manufacturer may result in fire, electric shock, or injury to persons.
- 8) Do not use this heater with programmer, timer, separate remote-control system or any other device that switches the heater on automatically, since a fire risk exists if the heater is covered or positioned incorrectly
- 9) Disconnect the power supply before cleaning, performing maintenance, or relocating the fireplace.
- 10) Keep the heater clean. Do not allow any objects to enter any ventilation or exhaust opening as this may cause electric shock, fire or damage to the heater.
- 11) Do not immerse the cord, plug or any part of the appliance in water or any other liquid
- 12) In order to avoid a hazard due to inadvertent resetting of the thermal cut-out, this appliance must not be supplied through an external switching device

CAUTION: Procedures and techniques, which, if not carefully followed, will result in damage to the equipment.

WARNING: Procedures and techniques, which if not carefully followed, will expose the user to the risk of fire, serious injury, illness or death.

FCC CAUTIONS

This device complies with part 15 of the FCC Rules. Operation is subject to the following two conditions: (1) This device may not cause harmful interference, and (2) this device must accept any interference received, including interference that may cause undesired operation.

Any Changes or modifications not expressly approved by the party responsible for compliance could void the user's authority to operate the equipment.

Note: This equipment has been tested and found to comply with the limits for a Class B digital device, pursuant to part 15 of the FCC Rules. These limits are designed to provide reasonable protection against harmful interference in a residential installation. This equipment generates uses and can radiate radio frequency energy and, if not installed and used in accordance with the instructions, may cause harmful interference to radio communications. However, there is no guarantee that interference will not occur in a particular installation. If this equipment does cause harmful interference to radio or television reception, which can be determined by turning the equipment off and on, the user is encouraged to try to correct the interference by one or more of the following measures:

Reorient or relocate the receiving antenna.

Increase the separation between the equipment and receiver.

Connect the equipment into an outlet on a circuit different from that to which the receiver is connected.

Consult the dealer or an experienced radio/TV technician for help.

This equipment complies with FCC radiation exposure limits set forth for an uncontrolled environment. This equipment should be installed and operated with minimum distance 20cm between the radiator & your body.

UNPACKING AND TESTING APPLIANCE

Carefully remove the appliance from the box.

Prior to installing the appliance, test to make sure the appliance operates properly by plugging the power supply cord into a conveniently located 120 Volt grounded outlet.

Test all aspects of its operation (manual switches, remote and heater) to make sure all components operate correctly.

As with most electronic devices, your electric fireplace has been designed to operate at temperatures between 5 °C (41°F) and 35°C (95°F). During the cold winter months, allow the fireplace to reach room temperature before turning it on.

NOTE: There may be trace of odor during the first few minutes of initial use. This is harmless, normal and will never occur again.

GROUNDING APPLIANCE

This appliance is for use on 120 volts. The cord has a plug as shown in (A). An adapter as shown in (C) is available for connecting three-blade grounding type plugs to two-slot receptacles. The green grounding lug extending from the adapter must be connected to a permanent ground such as a properly grounded outlet box. The adapter should not be used if a three-slot grounded receptacle is available.

To disconnect appliance, turn controls to off, then remove plug from outlet.

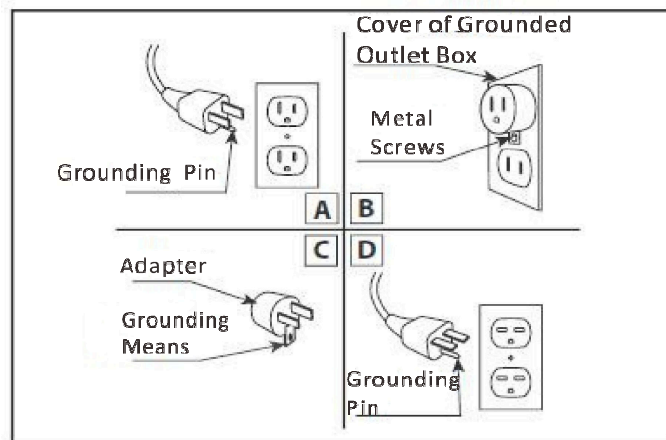

Note : Adaptor are NOT for use in Canada

CHOOSING A LOCATION FOR THE FIREPLACE

Plan where to place and frame the fireplace. Before installation consider the following:

1. The location of the fireplace must allow for wall and ceiling clearances.
2. Consider a location where the fireplace screen will not be exposed to direct sunlight from windows or doors.
3. A 15 ampere, 120 Volt, 60 Hz branch circuit with proper ground must be available at the location. A dedicated branch circuit should be provided to avoid circuit breakers to trip or fuses to blow.

E50 HO

Description	Free Standing Appliance	
Voltage	120VAC 60Hz	240VAC 60Hz
Watts	1500W Max	6000W Max
NO HEATER	18.5W	
MOTOR HEATER	19W	
Appliance Width	23 1/8" or 58.61 cm	
Appliance Height	28 1/4" or 71.7 cm	
Appliance Depth	17 1/2" or 44.3 cm	
Gross Weight	123.5 lbs or 56 kgs	
Plug Location	Left side	
Cord Length	70 7/8" or 180 cm	
BTU	5000	20000

This appliance has been tested in accordance with the UL Standard 2021 for fixed and location dedicated electric room appliances in the United States and Canada. If you need assistance during installation, please contact your local dealer.

NOTE: This appliance must be electrically wired and grounded in accordance with local codes. In the absence of local codes, use the current CSA C22.1 Canadian Electrical Code in Canada or the ANSI/NFPA 70 National Electrical Code in the United States.

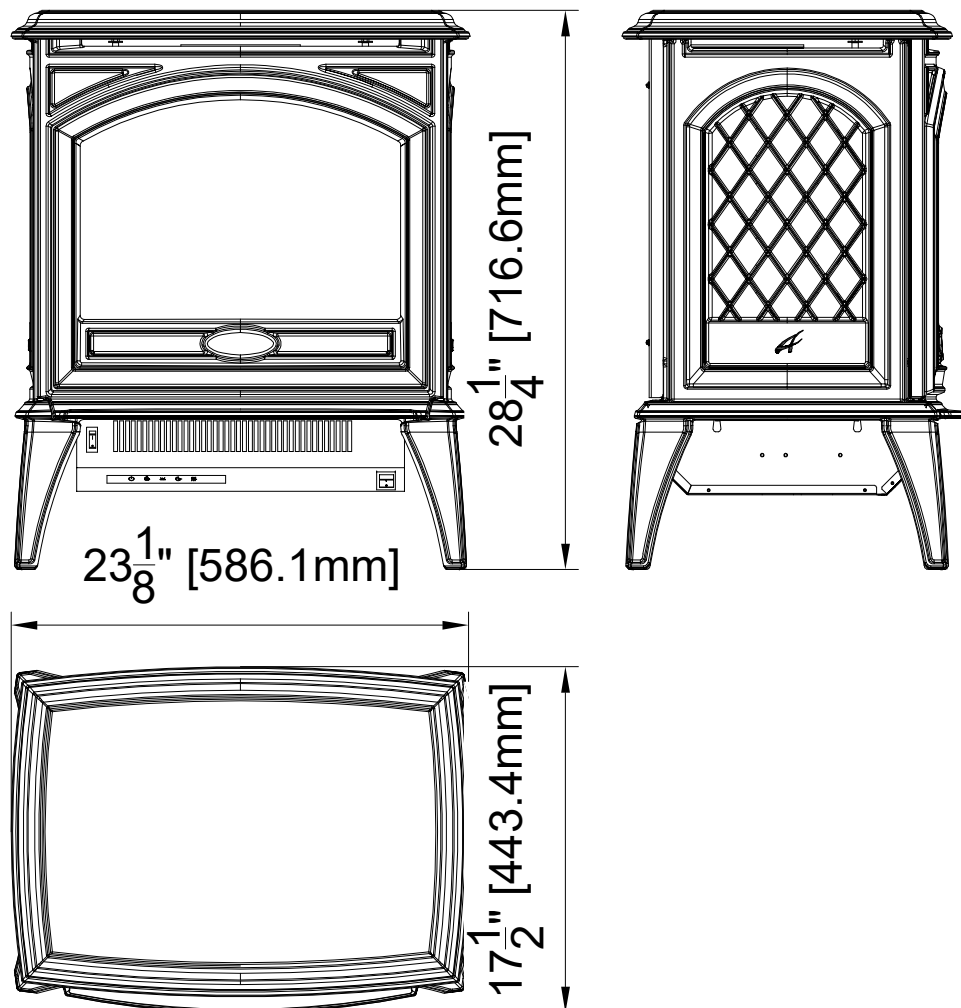

E70 HO

Description	Free Standing Appliance	
Voltage	120VAC 60Hz	240VAC 60Hz
Watts	1500W Max	6000W Max
NO HEATER	18.5W	
MOTOR HEATER	19W	
Appliance Width	27 7/8" or 70.81 cm	
Appliance Height	28 1/4" or 71.7 cm	
Appliance Depth	17 1/2" or 44.3 cm	
Gross Weight	140.9 lbs or 63.9 kgs	
Plug Location	Left side	
Cord Length	70 7/8" or 180 cm	
BTU	5000	20000

This appliance has been tested in accordance with the UL Standard 2021 for fixed and location dedicated electric room appliances in the United States and Canada. If you need assistance during installation, please contact your local dealer.

NOTE: This appliance must be electrically wired and grounded in accordance with local codes. In the absence of local codes, use the current CSA C22.1 Canadian Electrical Code in Canada or the ANSI/NFPA 70 National Electrical Code in the United States.

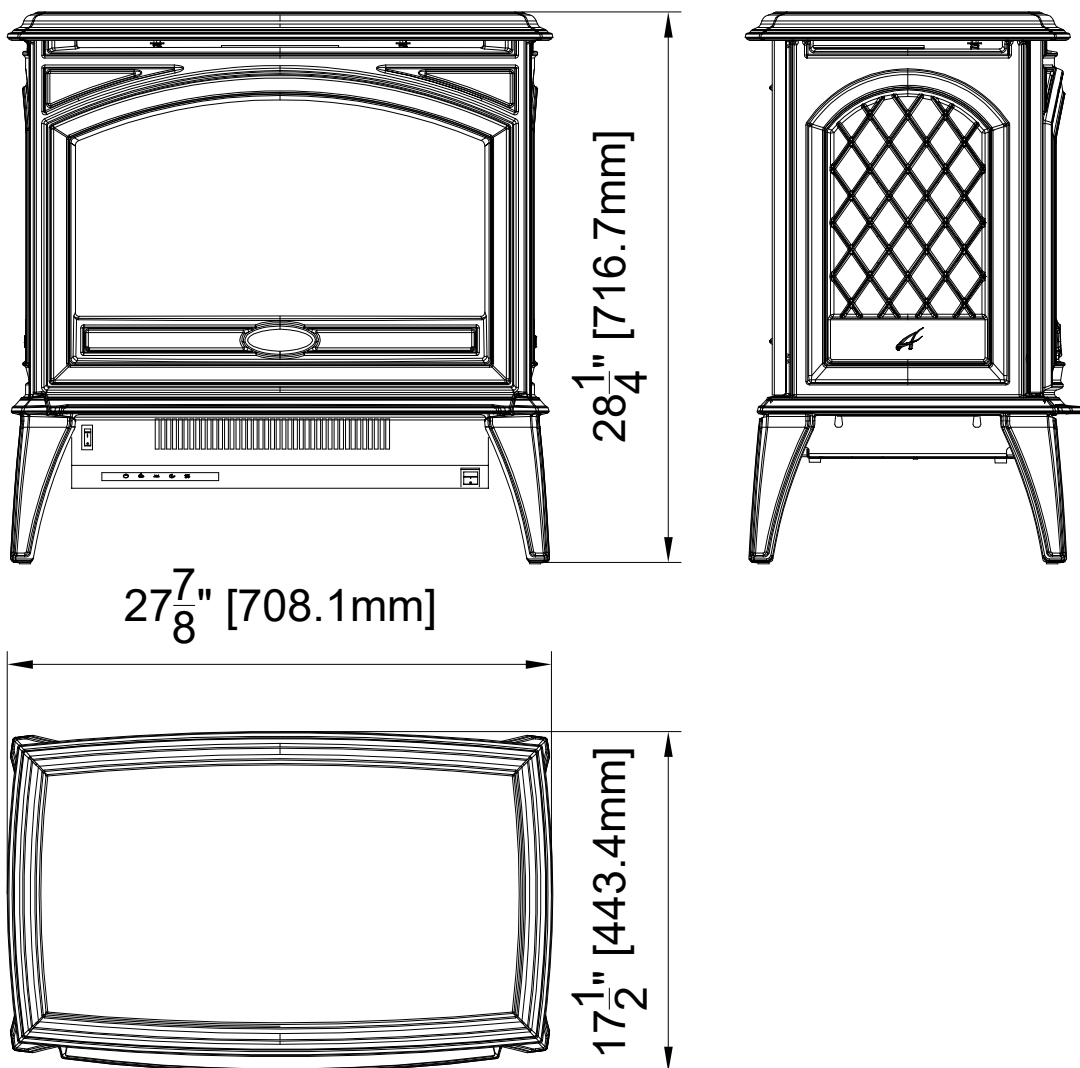

CLEARANCE

The clearance to the mantel should be 6" minimum when a mantel is applied. The clearance to the rear wall should be 1" minimum. The clearance to the side walls should be 3" minimum.
(Measurement is taken from the trim)

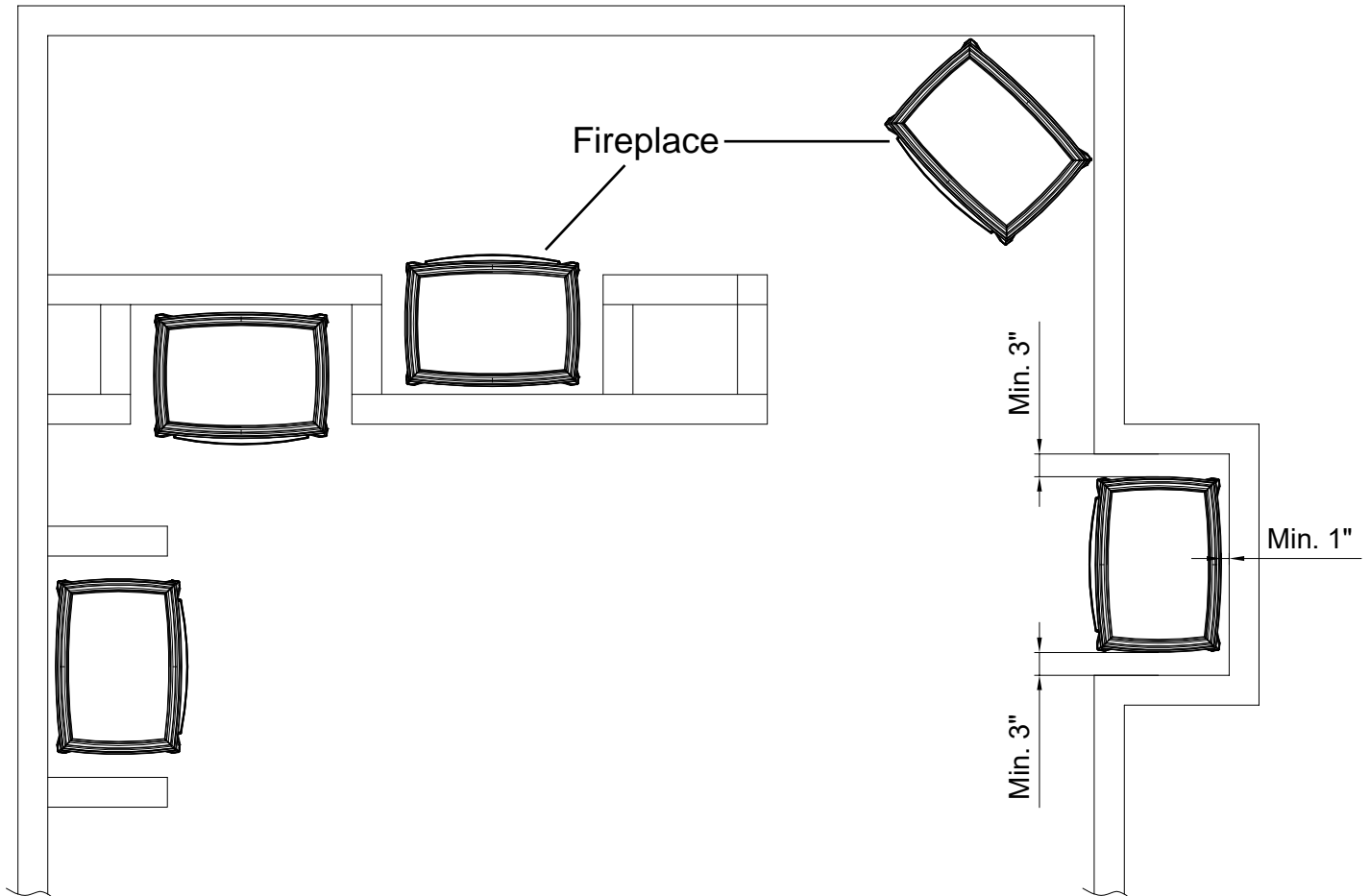

WIRING DIAGRAM

Wiring diagrams are provided here for reference purposes only. This information is also provided on schematics attached directly to the appliance on the top left corner.

CAUTION: LABEL ALL WIRES PRIOR TO DISCONNECTION WHEN SERVICING CONTROLS. WIRING ERRORS CAN CAUSE IMPROPER AND DANGEROUS APPLIANCE OPERATION.

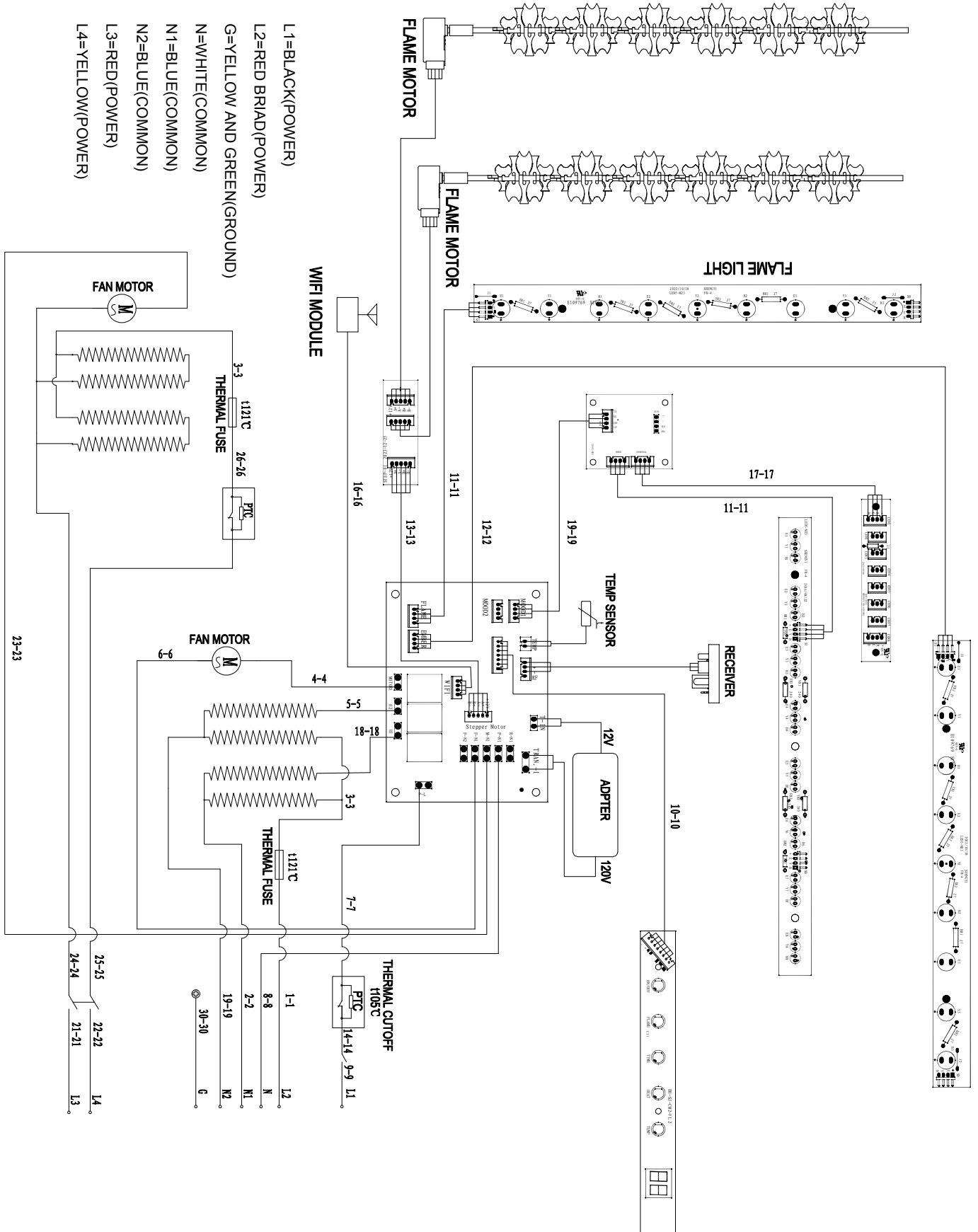

HARDWARE INSTALLATION

Turn off the appliance completely and let cool before servicing. Only a qualified service person should service and repair this electric appliance.

If it is necessary to hardwire this appliance, a qualified electrician must remove the cord connection, and wire the appliance directly to the household wiring.

This appliance must be electrically connected and grounded in accordance with local codes, if hardwired. In the absence of local codes, use the current CSA C22.1 CANADIAN ELECTRICAL CODE in Canada or the current ANS/NFPA 70 NATIONAL ELECTRICAL CODE in the United States.

HARDWIRE FOR FAN AND HEATER 1

1. Unscrew the screws to get the terminal block out of the cassette.



2. Unscrew the screws to get the power cord and steel plate off.

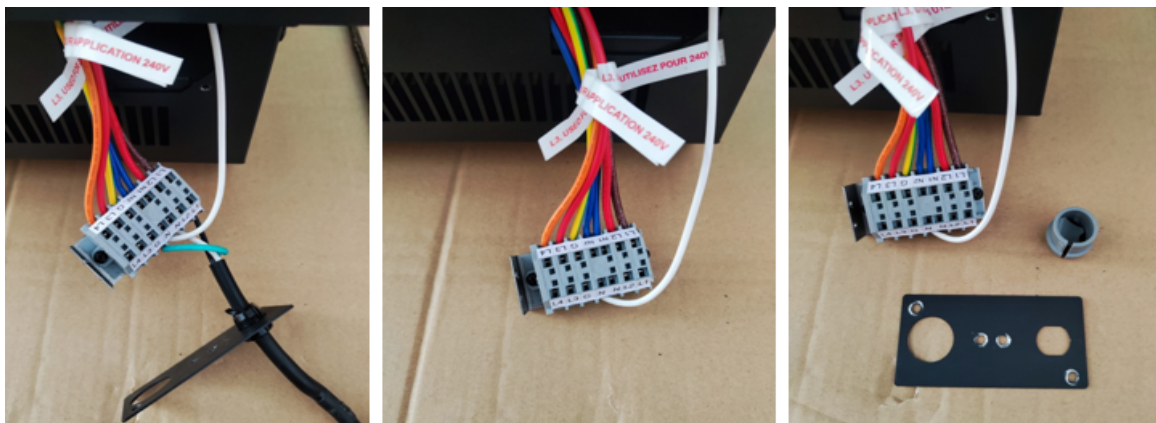

3. Get the strain relief from the manual bag and put it into the steel plate.
4. Screw the steel plate back to the terminal block as show
5. Insert the Neutral / Live / Ground wires.

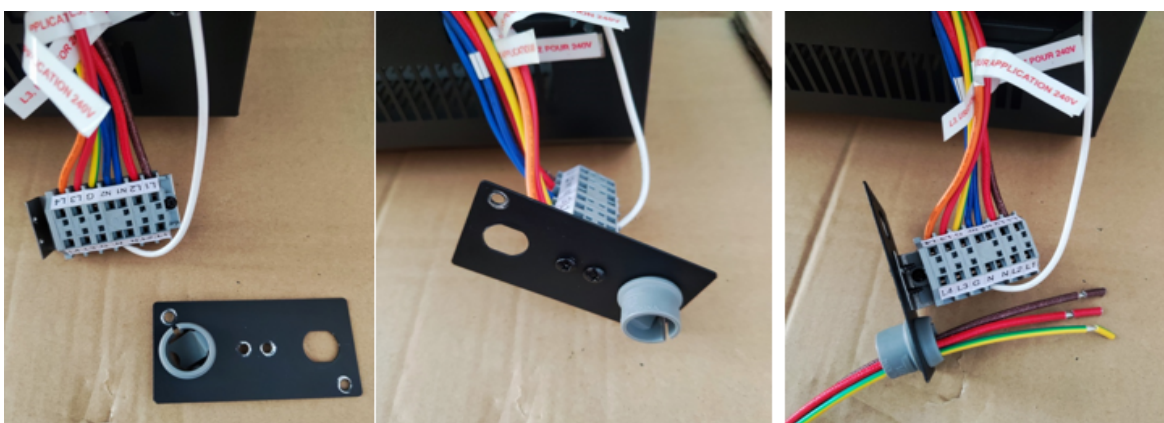

NOTE: Use a screwdriver push the spring to release the wire from the terminal block.

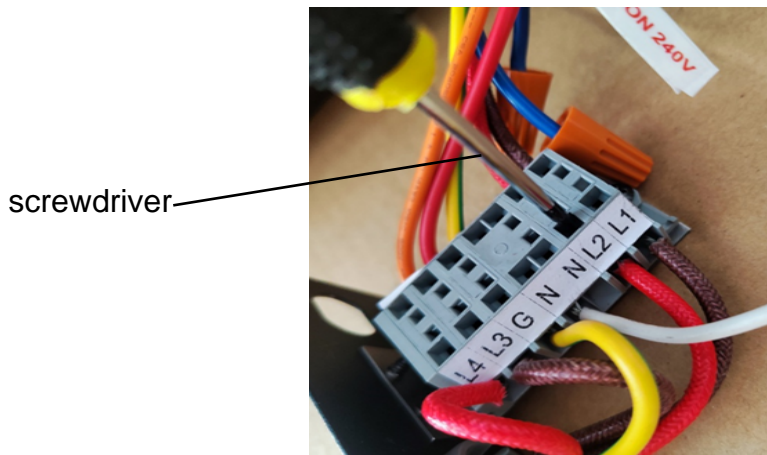

6. Release N1 and N2 wires and cover with plastic cap.
7. Insert the Live/ Neutral / Ground wires into the terminal block.
8. Screw back the steel panel set.

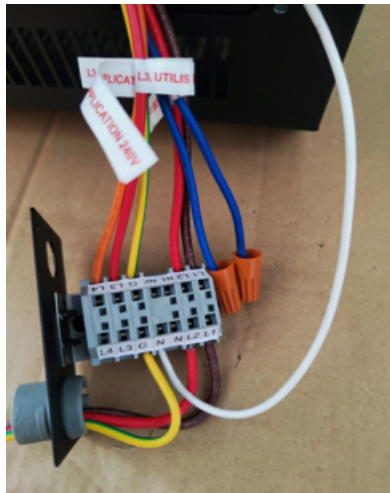

HARDWIRE FOR FAN AND HEATER 2

9. Insert wire L3 and L1 to power supply L1, wire L4 and L2 to power supply L2, the second fan and heater at the bottom is connected. Switch on/off the big switch on the right to turn on/off the second fan and heater.

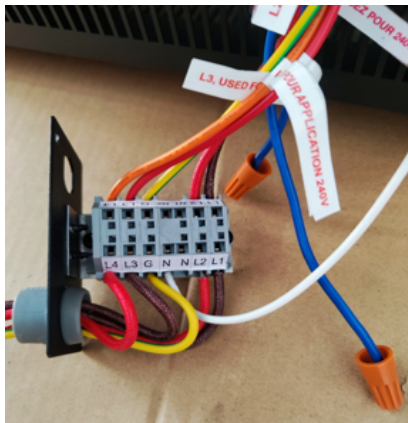

For more information, see page 12 to 13.

HARDWIRE INSTALLATION

1. 120V 15Amp 60Hz only

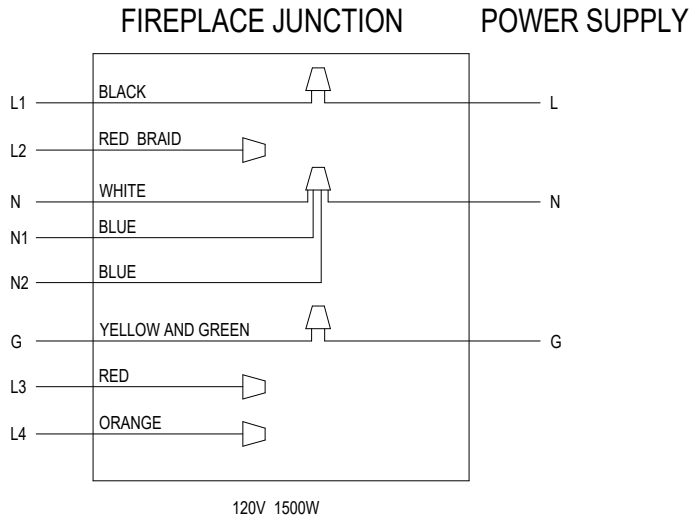

The unit is preset with one power cord, switch on the main power switch and turn on the heater, there are 2 sets of the heating, running at H1 750W or H2 1500W.

IF THE APPLIANCE IS TO BE HARD WIRED IN, THE POWER CORD MUST BE REMOVED

2. 240V 30Amp 60Hz only

2.1. One set of heater

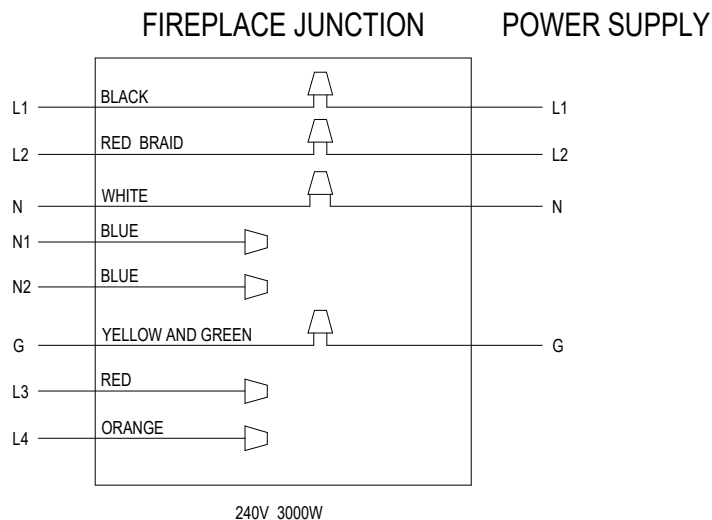
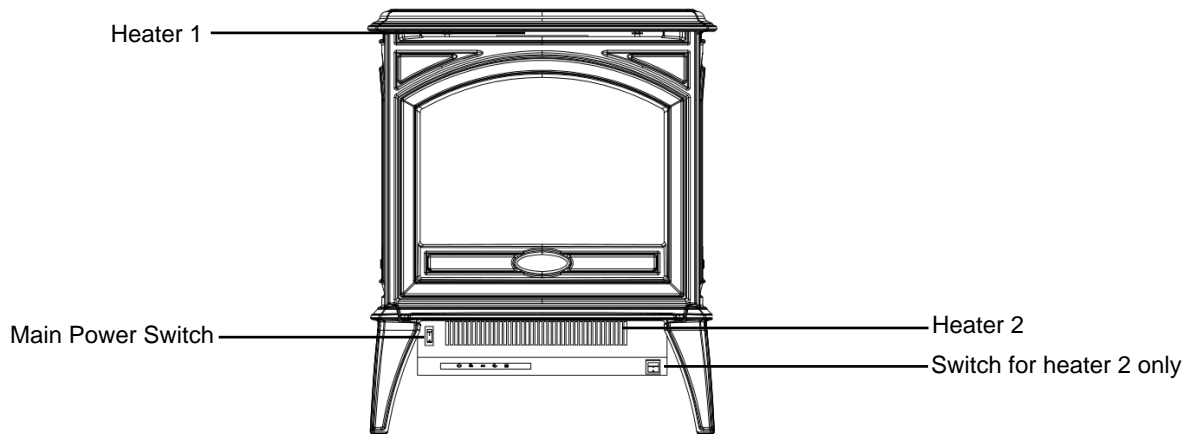

After hardwire, switch on the main power switch and turn on the heater, there are 2 sets of the heating, running at H1 1500W or H2 3000W.

IF THE APPLIANCE IS TO BE HARD WIRED IN, THE POWER CORD MUST BE REMOVED

2. 2 Two sets of heater

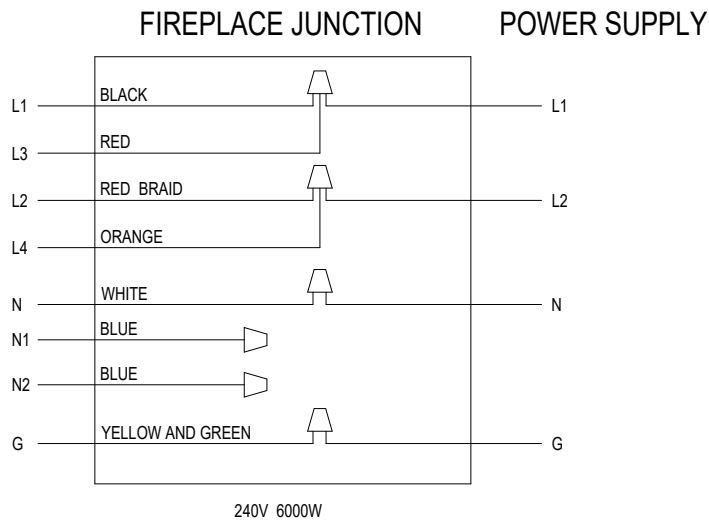
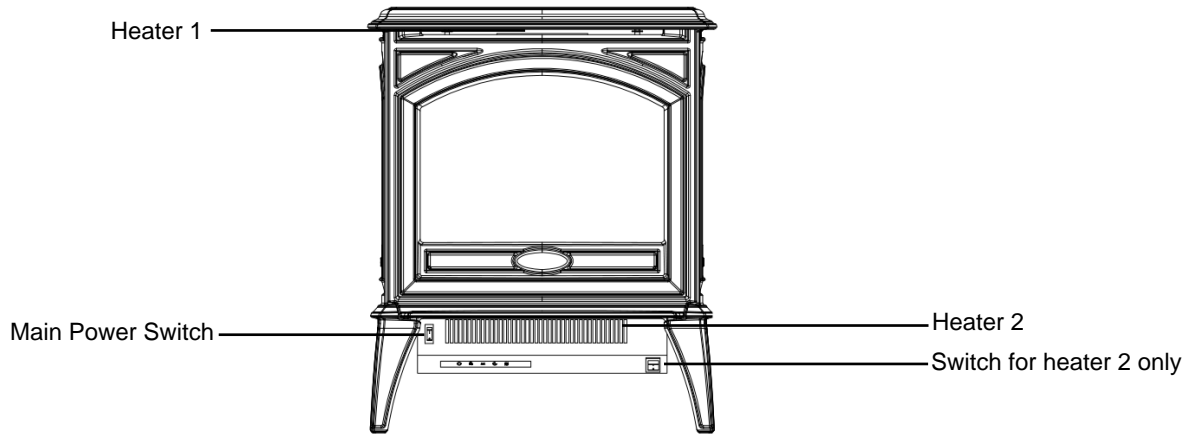

2. 2. 1 Running one set of heater

After hardwire, switch on the main power switch and turn on the heater, there are 2 sets of the heating, running at H1 1500W or H2 3000W.

IF THE APPLIANCE IS TO BE HARD WIRED IN, THE POWER CORD MUST BE REMOVED

2. 2. 2 Running two sets of heater

After hardwire, switch on the switch for heater 2 only and turn on the heater, running at 3000W; switch on the main power switch, the switch for heater 2 only and turn on the heater, there are 2 sets of the heating, running at H1 4500W, or H2 6000W.

IF THE APPLIANCE IS TO BE HARD WIRED IN, THE POWER CORD MUST BE REMOVED

NOTE: ONLY A QUALIFIED ELECTRICIAN SHOULD DO THE JOB!

MEDIA OPTIONS

Your fireplace shipped with below media.



STEP 5: Unscrew the screws and take off the front glass panel.



MEDIA INSTALLATION

STEP 1: Unplug the unit and make sure controls are switched off.

STEP 2: Take off the top cover.



STEP 6: Now you can decorate your fireplace.

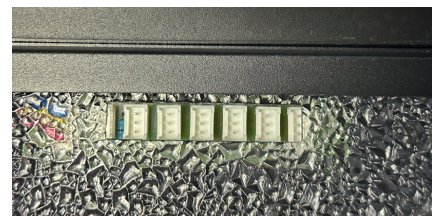

Socket for the LIT LOG



STEP 3: Unscrew 4 screws to take off the hot air tunnel.

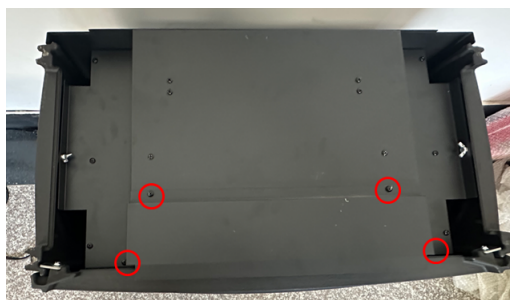

Plug the LIT LOG into the socket in the middle of the tray board.



STEP 4: Pull the front door up and take it off.

Place the decorative logs and media.

STEP 7: After the media has been installed, reinstall the front glass panel front door and top cover.

OPERATION





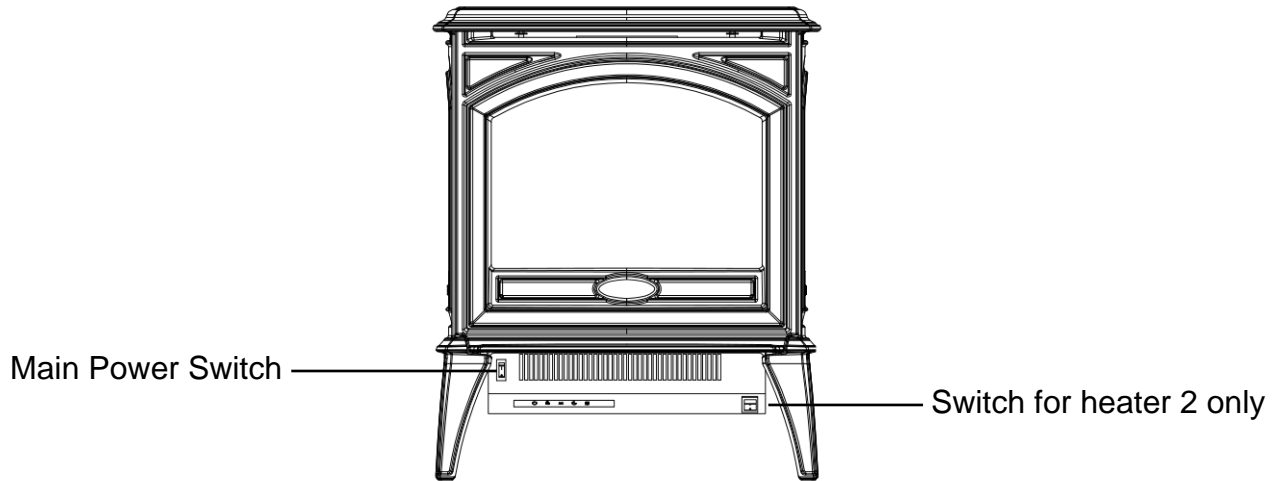

The Fireplace operates by using either the touch panel located on the upper left hand corner or by remote control.

Plug the fireplace into a 15 Amp wall socket.



MANUAL OPERATION













1. Press  to turn on and off the fireplace.
2. Press  to adjust the flame's brightness. There are 7 brightness levels (L5 – L4 - L3 – L2 – L1 – L0 – L6). The indicator light turns off automatically leaving it not operated within 10 seconds.
3. Press  to adjust the ember bed brightness. There are 12 brightness levels (D4 – D5 – D6 – D7 – D8 – D9 – DA – DB – D0 – D1 – D2 – D3).
4. Press  to set the turn-off time, 30min-1h-2h-3h-4h-5h-6h-7h-8h-t0. The indicator light turns off automatically leaving it not operated within 10 seconds. The timing turns off when  is pressed.
5. Press  to turn on and off the heater in its AUTO mode. The setting temperature switch through 59°F - 61°F - 63°F - 64°F - 66°F - 68°F - 70°F - 72°F - 73°F - 75°F - 77°F - 79°F - 81°F - 83°F - °F in Fahrenheit or 15°C -16°C -17°C - 18°C - 19°C - 20°C - 21°C - 22°C - 23°C - 24°C - 25°C - 26°C - 27°C - 28°C - °C in Celsius. The temperature setting mode will be closed automatically if leaving not operated for 5 seconds.
6. When the heater is on, press the  for 5 seconds to switch between Celsius and Fahrenheit.

REMOTE CONTROL OPERATION

For remote to function make sure the fireplace is plugged in and the remote has batteries.

Important: When operating the remote make sure you point the remote to the center of the fireplace. Each time you press the button, the buzzer inside the unit will beep once. It takes some time for the receiver to respond to the transmitter. Do not PRESS the buttons more than once within two seconds for correct operation.

Set the current time of the remote control

Press the  to activate the remote control and press to set  the time and date. When one of the “Sun” “Mon” “Tue” “Wed” “Thu” “Fri” “Sat” is flashing, press  or  to set the day of the week, press  to confirm day of the week and then enter hour setting. Press  or  to set the hour, press  to confirm the hour and then enter minute setting. Press  or  to set the minute and press  to confirm the minute and finish time setting.

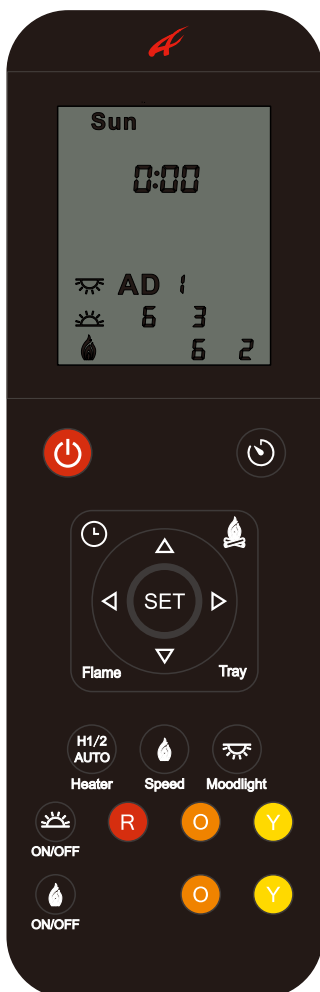

Press this Power button to turn on and off the fireplace.



Press this Timer button to set the time to turn off the fireplace. The available settings range from 30 minutes to 8 hours. As shown in the following: 0:30 - 1:00 - 1:30 - 2:00 - 2:30 - 3:00 - 3:30 - 4:00 - 4:30 - 5:00 - 5:30 - 6:00 - 6:30 - 7:00 - 7:30 - 8:00. Once you have set the timer, the  icon will be displayed on the LCD screen of the remote control. Press this button again to cancel the timer setting and the icon disappears.







Press this button to turn on and off the LIT log light.



Each time the Heater Button is pressed, the power of the heater will change. As shown the following: H1- H2- AUTO (72°F or 22°C) - OFF (no display)

H1 means the fireplace on Low Heat at 750W.

H2 means the fireplace operates at 1500W.

AUTO means fireplace can automatically adjust to the temperature you set. When in AUTO, you can set the desired temperature with  or  keys. You can switch temperature between Celsius and Fahrenheit with  or  keys. When it is on Auto mode, fireplace operate at 1500W.





Press this button to adjust the speed of the flame. There are 3 options: High-Medium- Low.





Press the Moodlight button to turn on and off the moodlight. When in ON position, the display screen of the remote control shows AD 1. When the number “1” flashes, press the button to set the color. There are 10 different colors (AD1–10) dynamic, and turnoff (AD 12) to choose from.



Press this button to turn on and off the tray light. When in ON position, the LCD screen of the remote control shows 6 3 0. Press  or  or  to change the brightness of each tray color.

















Press this button to turn on and off the flame light. When in ON position, the LCD screen of the remote control shows 6 2. Press  or  to change the brightness of each flame color.









There are preset color combinations of flame and tray light, press “Flame” or “Tray” to choose your desired flame light or tray light color combination.

7 Day Timer Function

Press  once, 7 days from Monday to Sunday will display on the LCD screen of the remote control, press  within 5 seconds to enter 7 day timer function. When “Sun” flashes, press  or  to select the day that you want to set, press  to confirm your setting. Then “ON” will be display on the LCD screen of the remote control, at the same time, digital of time hour flashes, press  or  to set the time to turn the fireplace on. After setting the startup time, “OFF” will be displayed on the LCD screen and press  or  to set the shutdown time. When the shutdown time’s set, “AUTO” will be displayed on the LCD screen of the remote control and the digital of temperature flashes. At this time, you can set the temperature by  or . Now, you have finished setting of this function.

When the 7 day timer’s set, the icon  will be displayed on the LCD screen of the remote control. Press  again to cancel the 7 day timer and the icon  will disappears.

NOTE: If the 7 day timing  and the general timing  are set at the same time, the system will respond to an earlier shutdown time.

 Press Refer button to check the settings of 7 day timer. Press  or  to see the settings of the day of the week and  or  the settings of the startup and shutdown time.

WIFI OPERATION

INSTALL TuyaSmart life

There are 2 ways to install TuyaSmart;

1. Search for “TuyaSmart life” in the APP store on your phone, download and install.
2. Scan the QR code below with your mobile phone.



WIFI SETTING AND FIREPLACE OPERATION

NOTE: Make sure the Bluetooth of your phone is turned on during the following steps.

1. Create an account and log in.
2. When you log in, touch “+” (FIG.1) to enter in FIG.2. Touch “Small Home appliances” on the left side and then choose “Electric Fireplace (BLE+Wi-Fi)” to enter in FIG.3 to reset the device.

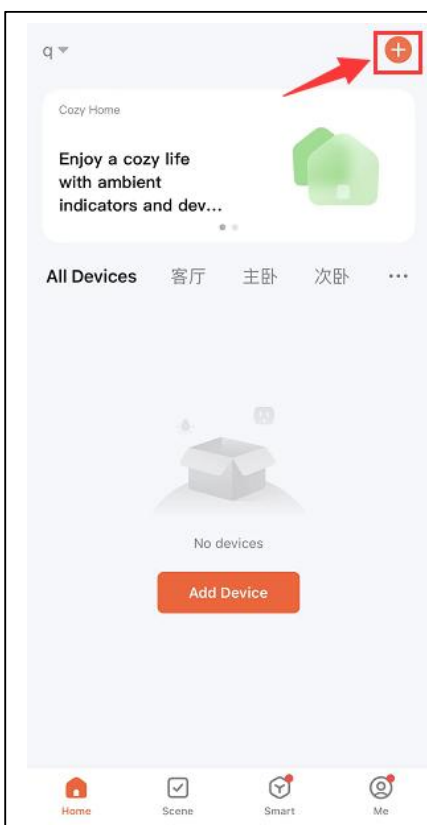

FIG.1



FIG.2



FIG.3

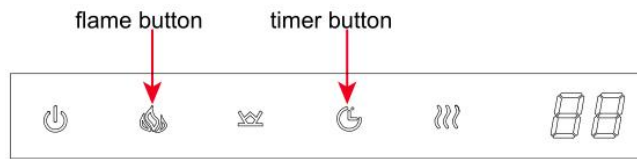

FIG.4

3. Press the flame button until the timer button flashes(FIG.4). Then confirm to go next to set your Wi-Fi account and password (FIG.5). Please make sure the Wi-Fi account and password you set are correct and Wi-Fi signal is good.
4. The APP will search and recommend the devices automatically (FIG.6) for you to add to.
5. Touch “Done” to finish Wi-Fi setting. (FIG.7)

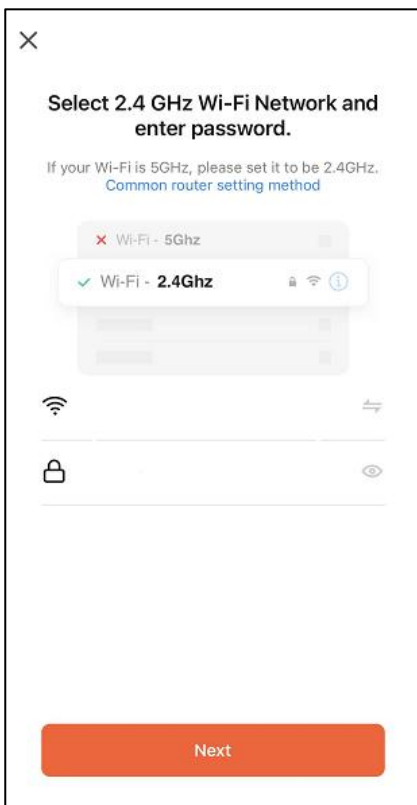

FIG.5

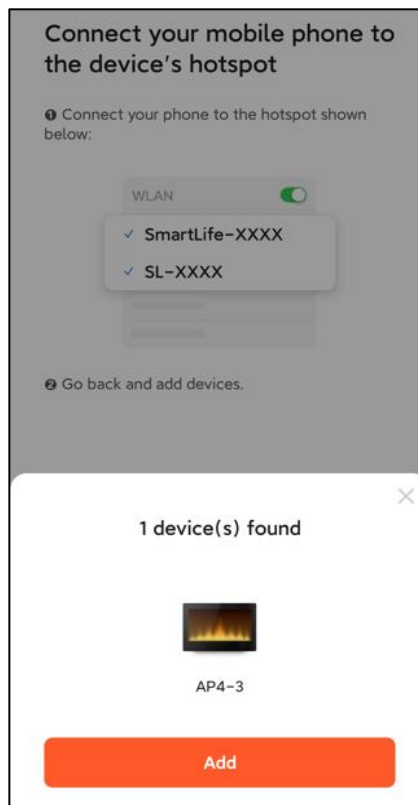

FIG.6

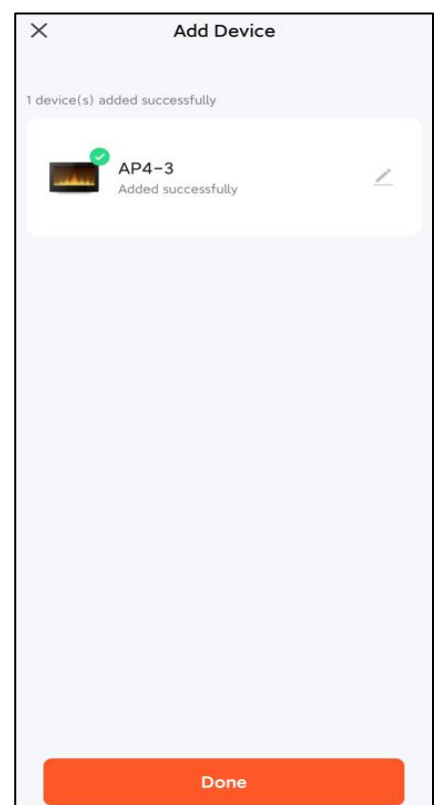

FIG.7

6. Now you are in the interface like FIG.8. You can operate the fireplace via Wi-Fi (FIG.8/ FIG.9/ FIG.10/ FIG.11).

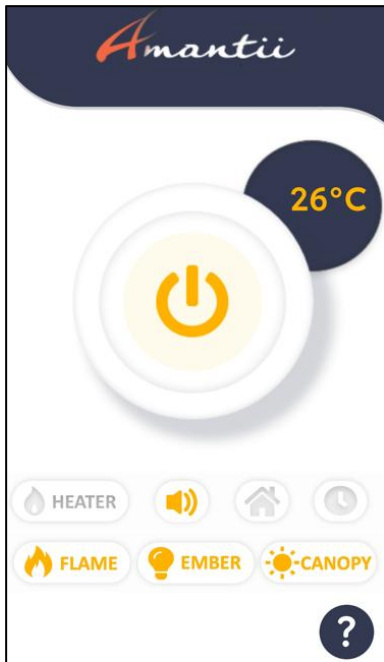

FIG.8

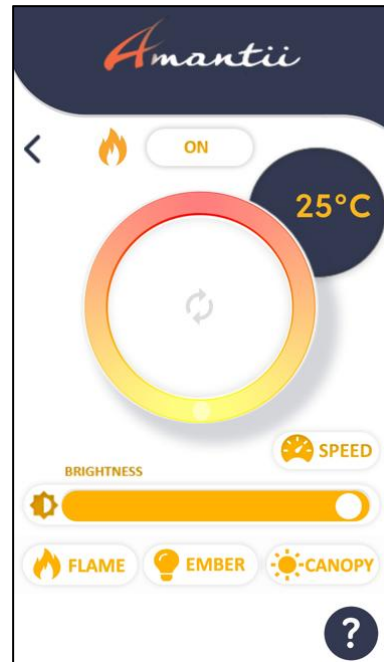

FIG.9

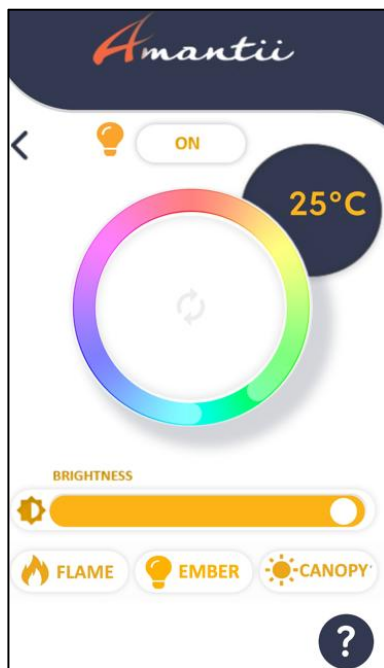

FIG.10

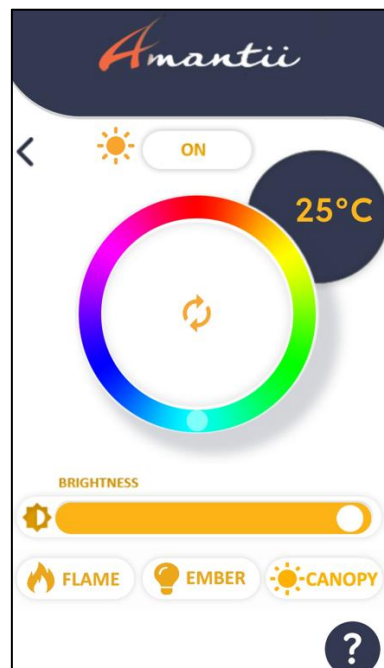
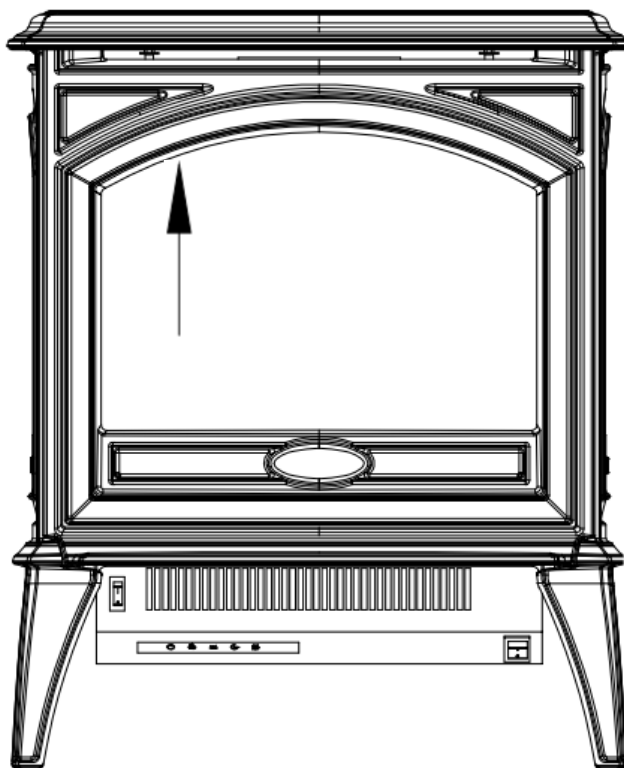

FIG.11

REPLACEMENT PARTS

There is a QR code where the arrow is marked in below image (The QR code is on the left top behind the front glass). Scan the code to get the replacement parts list for your reference. You will get a detailed parts list with images.



***There is a QR code in page 2 of the manual, at the bottom of the table of contents.**

REPLACEMENT PARTS

This list contains replacement parts

NO	DESCRIPTION	PART NUMBER		QTY
		E50-HO	E70-HO	
1	FRONT GLASS	10701381	10701382	1/1
2	FLICKER MOTOR	10101501	10101501	2/2
3	FLICKER	3224505B	3225505B	2/2
4	TRAY LIGHT	10124497	10124498	1/1
5	TRAY	3224023	3225023	1/1
6	BACK GLASS	10702262	10702264	1/1
7	TOP LIGHT	601139C	601139C	1/1
8	POWER SWITCH	10104010	10104010	1/1
9	POWER SWITCH FOR BOTTOM FAN AND HEATER	10104031	10104031	1/1
10	FAN AND HEATER	602019	602019	2/2
11	FLAME LIGHT	10124497B	10124498B	1/1
12	REMOTE RECEIVER	3001506B	3001506B	1/1
13	MAIN PCB BOARD	10124129M	10124129M	1/1
14	WI-FI CARD	212052	212052	1/1
15	TOUCH PANEL	10124003B	10124003B	1/1
16	POWER ADAPTOR	10116003	10116003	1/1

*WI-FI card, touch panel and power adaptor are not shown at the exploded view

*Items may not appear exactly as illustrated

EXPLODED VIEW

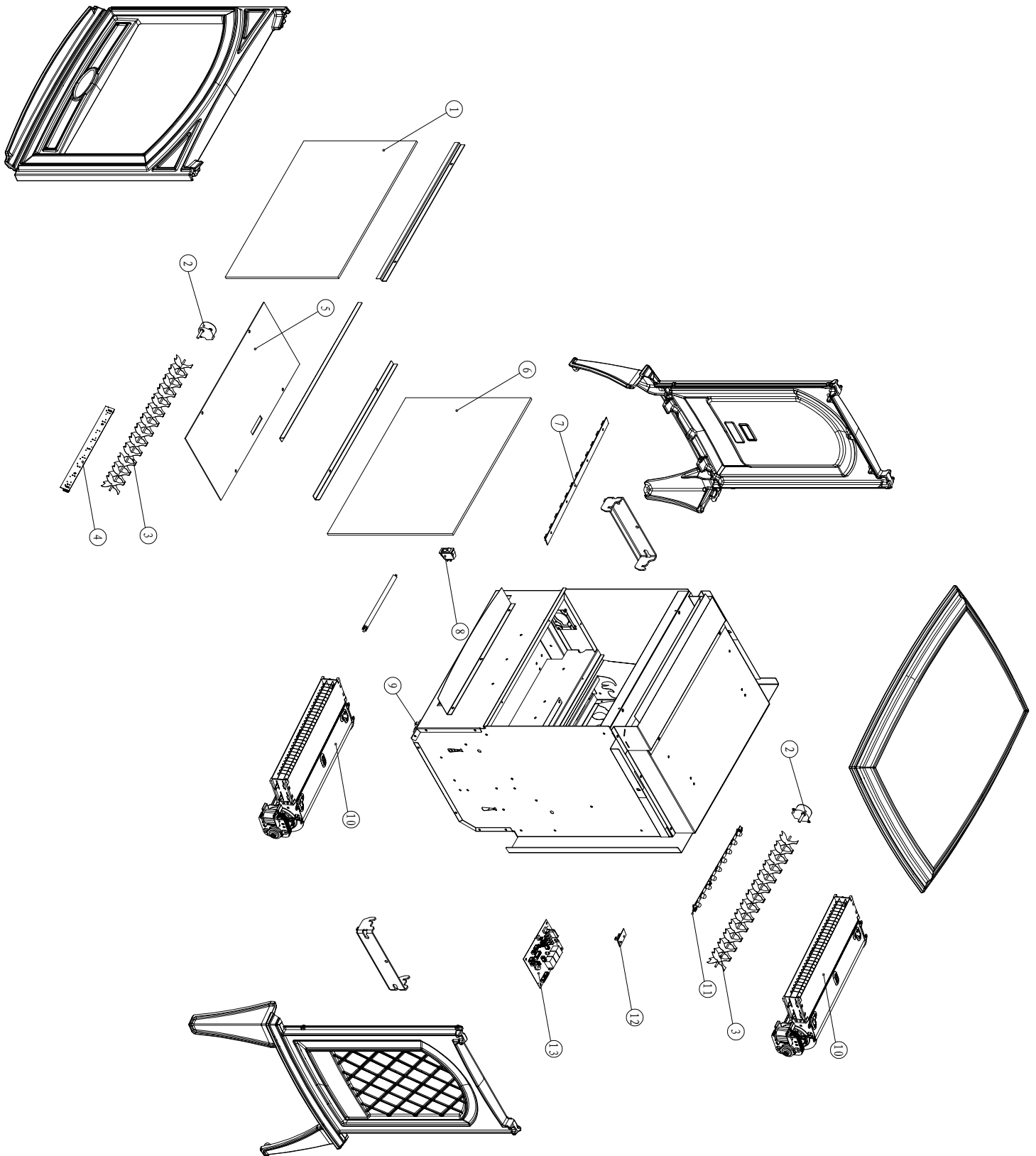

TROUBLESHOOTING

PROBLEM	POSSIBLE CAUSE	SOLUTION
Dim or no flame	Flame LED's are burnt out.	Inspect the LED's and replace them if necessary.
	Back black cloth is falling off and rolled up in the flicker.	Change a flicker and back black cloth.
Ember bed is not glowing or dimming	Ember LED's are burnt out	Inspect the ember bed LED's and replace them if necessary.
Appliance turns off and will not turn on	Appliance has overheated, and safety device has caused the thermal switch to disconnect.	Turn off the main switch, allow appliance to cool for 10 minutes, turn back on.
	House circuit breaker has tripped.	Reset house circuit breaker.
	Appliance's fuse has blown.	Replace the fuse.
Appliance will not come on when switch is flipped to ON	Appliance is not plugged into an electrical outlet.	Check plug and plug in.
	Appliance has overheated and safety device has caused the thermal switch to disconnect.	Turn off the main switch, allow appliance to cool for 10 minutes, turn back on.
	Circuit board is burnt out.	Inspect the circuit board and replace it if necessary.
No warm air coming out of appliance	Heater is burnt out.	Inspect the heater assembly and replace it if necessary.
Flame sputters	Flame motor is defective.	Call a qualified service technician and replace flame motor.
Remote Control does not work.	Low batteries. Unit switch in "O" position.	Replace AAA batteries in remote control. Turn the switch in "I" position.
Flame is fixed.	Wiring may be loose or the flame motor may be defective.	

1 YEAR LIMITED WARRANTY



Amantii Imports Corp. One-Year Limited Warranty

Amantii Imports Corp. ("Amantii") warrants that your newly purchased Amantii electric fireplace is free from manufacturing and material defects for a period of one (1) year from the date of original purchase, subject to the terms, conditions, and limitations outlined below.

WARRANTY APPLICATION & EXCLUSIONS

This limited warranty applies exclusively to Amantii electric fireplaces purchased in Canada or any of the 50 States of the United States, including the District of Columbia. It is extended only to the original purchaser and is non-transferable. Proof of purchase from an authorized supplier is required.

WARRANTY COVERAGE AND TERM

Products covered under this warranty have been factory-tested and inspected prior to shipment. Amantii warrants that these products are free from defects in material and workmanship under normal use and service for one (1) year from the date of original purchase.

Where applicable, any implied warranties are also limited to one (1) year, unless restricted by local law.

ADDITIONAL WARRANTY CONDITIONS

Proper Installation & Operation:

This electric fireplace must be installed and operated in full compliance with the installation and operating instructions provided. Any unauthorized repair, modification, misuse, accident, or abuse will immediately void the warranty.

Original Owner Only:

This warranty applies only to the original owner, provided the product was purchased through an authorized Amantii dealer.

Defect Confirmation:

Warranty coverage is limited to repair or replacement of parts confirmed to be defective in material or workmanship after inspection by Amantii. Defective parts must have been subject to normal use and conditions.

Refund Option:

Amantii reserves the right to discharge all warranty obligations by refunding the wholesale price of the defective part(s).

Warranty Voids Include (but are not limited to):

- a. Exposure to prolonged moisture or condensation.
- b. Unauthorized alterations, willful abuse, accidents, or misuse.
- c. Failure to present original proof of purchase.

Costs Not Covered:

This warranty does not cover labor, installation, construction, transportation, or other incidental costs related to service, repair, or replacement of defective parts.

Limitation of Liability:

The owner/user assumes all other risks, including direct, indirect, or consequential damages arising from the use—or inability to use—the product, except where prohibited by law.

No Additional Warranties:

All other warranties—expressed or implied—relating to the product, its components, or accessories, are hereby excluded.

No Third-Party Authority:

Amantii does not authorize any third party to create or assume obligations or liabilities on its behalf regarding this product.

Exclusion of Third-Party Accessories:

This warranty does not apply to any third-party components or accessories used in conjunction with this product.

WARRANTY SERVICE

To initiate a warranty claim, please contact Amantii Technical Support at:

1 YEAR LIMITED WARRANTY



Amantii Imports Corp. One-Year Limited Warranty

1.877.850.9458
502-1027 Davie Street, Vancouver,
BC V6E 4L2

Please have your proof of purchase, model number, and serial number available.

DEFECT RESOLUTION

If a defect covered by this warranty is confirmed within the one (1) year warranty period, Amantii will replace the defective product or part at no charge. If replacement is not commercially feasible, Amantii may opt to refund the purchase price in lieu of replacement.

APPLICATION OF PROVINCIAL AND STATE LAW

This limited warranty gives you specific legal rights, and you may also have other rights which vary from one jurisdiction to another.

The provisions of the United Nations Convention on Contracts for the Sale of Goods do not apply to this limited warranty or to the sale of any products covered by it.

GENERAL TERMS

Amantii reserves the right to make changes at any time, without prior notice, to the design, materials, specifications, or pricing of its products. The company also reserves the right to discontinue any product or style without incurring any obligation.

Please note:

This limited warranty does not apply to the plastic tray, LED Lights, back glass, or front glass of the unit.

CONTACT INFORMATION

Canada Order Desk:

Phone: 877.850.9458 - Ext 3
Email: westcanorders@cannedheat.com
Email: eastcanorders@cannedheat.com

USA Order Desk:

Phone: 877.850.9458 - Ext 2
Email: usaorders@cannedheat.com

Technical Support:

Phone: 877.850.9458 - Ext 5
Email: cdn-service@amantii.com

Headquarters:

Phone: 604.684.6040

Explore More from Cannedheat



Thank you for purchasing a Cannedheat product – Where Innovation Meets Ambience

At Cannedheat, we're passionate about redefining comfort and style through cutting-edge fireplace solutions. With decades of industry expertise, our mission is to deliver exceptional design, quality, and performance across a wide range of electric and gas fireplace products.

Our Brand Portfolio:

Explore our family of trusted brands, each offering unique features and styles to suit any space:

Amantii Electric fireplace – Sleek, modern electric fireplaces built for indoor and outdoor living. Innovation and elegance at its finest.



Remii Electric Fireplace – Versatile and stylish fireplaces designed for both residential and commercial applications.



Sierra Flame – High-performance gas fireplaces that blend classic aesthetics with modern technology.



Fire & Ice – A bold line known for its vibrant flame colors and contemporary feel, adding personality to any room.



Whether you're a homeowner, designer, or builder, Cannedheat has the perfect solution to bring warmth and style into your space.

CONTACT INFORMATION

Canada Order Desk:

Phone: 877.850.9458 - Ext 3
Email: westcanorders@cannedheat.com
Email: eastcanorders@cannedheat.com

USA Order Desk:

Phone: 877.850.9458 - Ext 2
Email: usaorders@cannedheat.com

Technical Support:

Phone: 877.850.9458 - Ext 5
Email: cdn-service@amantii.com

Headquarters:

Phone: 604.684.6040

What Our Other Brands Offer



Discover the unique strengths of each Cannedheat brand. Use this quick comparison guide to find the right fit for your space, style, and budget.

Brand	Key Products / Focus	Unique Features	Best For
Amantii	Premium Electric Fireplaces	Customizable log sets, Wi-Fi enabled, Bluetooth compatible	Designers, custom home builds
Remii	Standard Electric Fireplaces	Clean design, easy installation, reliable performance	Homeowners, contractors, quick projects
Fire & Ice	Budget-Friendly Electric Fireplaces	Bold flame effects, modern look at an accessible price	First-time buyers, apartments, rentals
Sierra Flame	Gas Fireplaces	Realistic flame, high heat output, traditional and modern models	High-performance heating, classic homes

CONTACT INFORMATION

Canada Order Desk:

Phone: 877.850.9458 - Ext 3
Email: westcanorders@cannedheat.com
Email: eastcanorders@cannedheat.com

USA Order Desk:

Phone: 877.850.9458 - Ext 2
Email: usaorders@cannedheat.com

Technical Support:

Phone: 877.850.9458 - Ext 5
Email: cdn-service@amantii.com

Headquarters:

Phone: 604.684.6040

Stay Connected with All Our Brands



Explore More. Shop Smarter. Stay Inspired.

Visit Our Brand Websites

Learn more, browse our full collections.

Brand	Website
Amantii (Modern Electric Fireplaces)	www.amantii.com
Sierra Flame (Gas Fireplaces)	www.sierraflame.com
Remii (Electric Fireplaces)	www.remii.com
Fire & Ice (Budget Friendly Electric Fireplaces)	www.fireandicefireplaces.com



Customer Support

We're here to help.

Phone: 1-888-406-8764

Email: support@amantii.com

Hours: Monday–Friday, 8am–4:30pm PST

What Our Customers Are Saying

“Our Amantii fireplace transformed our living space. Elegant, modern, and easy to use.”

— Sandra T., Toronto

“Top-notch support and a beautiful product. Highly recommended!”

— Mike R., Seattle

A Special Thank You

“Thank you for being a part of our journey. We invite you to discover everything our family of brands has to offer!”

Warm regards,

The Amantii Team

CONTACT INFORMATION

Canada Order Desk:

Phone: 877.850.9458 - Ext 3

Email: westcanorders@cannedheat.com

Email: eastcanorders@cannedheat.com

USA Order Desk:

Phone: 877.850.9458 - Ext 2

Email: usaorders@cannedheat.com

Technical Support:

Phone: 877.850.9458 - Ext 5

Email: cdn-service@amantii.com

Headquarters:

Phone: 604.684.6040